

Алматы (727)345-47-04
Ангарск (3955)60-70-56
Архангельск (8182)63-90-72
Астрахань (8512)99-46-04
Барнаул (3852)73-04-60
Белгород (4722)40-23-64
Благовещенск (4162)22-76-07
Брянск (4832)59-03-52
Владивосток (423)249-28-31
Владикавказ (8672)28-90-48
Владимир (4922)49-43-18
Волгоград (844)278-03-48
Вологда (8172)26-41-59
Воронеж (473)204-51-73
Екатеринбург (343)384-55-89

Россия +7(495)268-04-70

Иваново (4932)77-34-06
Ижевск (3412)26-03-58
Иркутск (395)279-98-46
Казань (843)206-01-48
Калининград (4012)72-03-81
Калуга (4842)92-23-67
Кемерово (3842)65-04-62
Киров (8332)68-02-04
Коломна (4966)23-41-49
Кострома (4942)77-07-48
Краснодар (861)203-40-90
Красноярск (391)204-63-61
Курск (4712)77-13-04
Курган (3522)50-90-47
Липецк (4742)52-20-81

Казахстан +7(727)345-47-04

Магнитогорск (3519)55-03-13
Москва (495)268-04-70
Мурманск (8152)59-64-93
Набережные Челны (8552)20-53-41
Нижний Новгород (831)429-08-12
Новокузнецк (3843)20-46-81
Ноябрьск (3496)41-32-12
Новосибирск (383)227-86-73
Омск (3812)21-46-40
Орел (4862)44-53-42
Оренбург (3532)37-68-04
Пенза (8412)22-31-16
Петрозаводск (8142)55-98-37
Псков (8112)59-10-37
Пермь (342)205-81-47

Беларусь +(375)257-127-884

Ростов-на-Дону (863)308-18-15
Рязань (4912)46-61-64
Самара (846)206-03-16
Санкт-Петербург (812)309-46-40
Саранск (8342)22-96-24
Саратов (845)249-38-78
Севастополь (8692)22-31-93
Симферополь (3652)67-13-56
Смоленск (4812)29-41-54
Сочи (862)225-72-31
Ставрополь (8652)20-65-13
Сургут (3462)77-98-35
Сыктывкар (8212)25-95-17
Тамбов (4752)50-40-97
Тверь (4822)63-31-35

Узбекистан +998(71)205-18-59

Тольятти (8482)63-91-07
Томск (3822)98-41-53
Тула (4872)33-79-87
Тюмень (3452)66-21-18
Улан-Удэ (3012)59-97-51
Ульяновск (8422)24-23-59
Уфа (347)229-48-12
Хабаровск (4212)92-98-04
Чебоксары (8352)28-53-07
Челябинск (351)202-03-61
Череповец (8422)49-02-64
Чита (3022)38-34-83
Якутск (4112)23-90-97
Ярославль (4852)69-52-93

Киргизия +996(312)96-26-47

<https://lamy.nt-rt.ru> || aym@nt-rt.ru

КАТАЛОГ



VISCOSITY

RHEOLOGY

TEXTURE

CONE & PLATE

KREBS-KU

THERMOCELL

TEMPERATURE CONTROL

VISCOSITY STANDARDS

CFR SOFTWARE

ON-LINE/PROCESS CONTROL

ASTM • DIN • ISO • BS • EN • IOCCC

Your Solutions to Sticky Problems!



FIRST PRODIG – GT300 PRODIG

The whole LAMY RHEOLOGY team is pleased to present the new FIRST PRODIG viscometer and the new Gel Timer GT300 PRODIG. These new instruments offer unparalleled ease of use. Equipped with the famous springless electronic motor developed by LAMY RHEOLOGY, they will allow you to create and save your methods, display results or curves, analyse your data and print reports. The FIRST PRODIG is compatible with all accessories of PLUS range, measuring systems and temperature control units. The GT300 PRODIG uses disposable accessories developed for our range of gel time analyser and benefits from same temperature supports developed for the Gel Timer GT300 PLUS. With optimized user management and data protection, they will be essential tools in your controls or product developments. Our entire team is at your disposal to come and present all our solutions for your measurements.



FIRST PRODIG

GT-300 PRODIG

HELIPRO STAND AND NEW ACCESSORIES



HELIPRO

Concerned about constantly optimizing measurement tools, LAMY RHEOLOGY innovates with new HELIPRO stand for measuring pasty products that tend to form cavities when rotating standard measuring spindle. Our new Small Volume Package optimizing the measurement on small quantities of products and our new THERMOCELL kit including an RT-1 PLUS high temperature oven and suitable measuring mobiles.



THERMOCELL PACKAGE



7**VISCOMETERS AND GELTIMERS**

- 8 B-ONE PLUS
- 10 FIRST PLUS
- 12 FIRST PRO
- 14 FIRST PRODIG
- 16 FIRST PRODIG CP 1000
- 18 RM 100 PLUS
- 20 RM 100 CP 1000 PLUS
- 22 RM 100 CP 2000 PLUS
- 24 GT-300 PLUS
- 26 GT-300 PRODIG

29**PORTABLES AND INDUSTRIALS
VISCOMETERS**

- 30 PORTABLE B-ONE
- 32 PORTABLE RM 100
- 34 RM 100 i
- 36 RM 100 L

39**RHEOMETERS**

- 40 RM 200 PLUS
- 42 RM 200 CP 4000 PLUS
- 44 DSR 500
- 46 DSR 500 CP 4000 PLUS

49**TEXTURE ANALYZER**

- 50 TX-700
- 52 PROBES
- 53 FIXTURES

57**TEMPERATURE CONTROLS**

- 58 EVA MS-DIN PLUS & MS-DIN/MS-R
- 59 EVA MS-R PLUS
- 60 EVA LR PLUS
- 61 RT-1 PLUS + THERMOCELL PACKAGE

63**ACCESSORIES**

- 64 RHEOTEX SOFTWARE
- 66 HELIPRO STAND
- 67 WATER JACKET + SMALL VOLUME PACKAGE
- 68 ACCESSORIES

71**MEASURING SYSTEMS**

- 72 MS-DIN
- 74 MS-R
- 75 MS-RV / MS-LV
- 76 MS-BV
- 77 MS-VANES / MS-KREBS
- 78 MS-CHOCOLAT / MS-ULV
- 79 MS-SV
- 80 MS-CP

83**SERVICES AND SUPPORT**

- 84 APPLICATIONS
- 85 TRAINING
- 86 CHECKING, CALIBRATION
AND SERVICE
- 87 DISTRIBUTORS

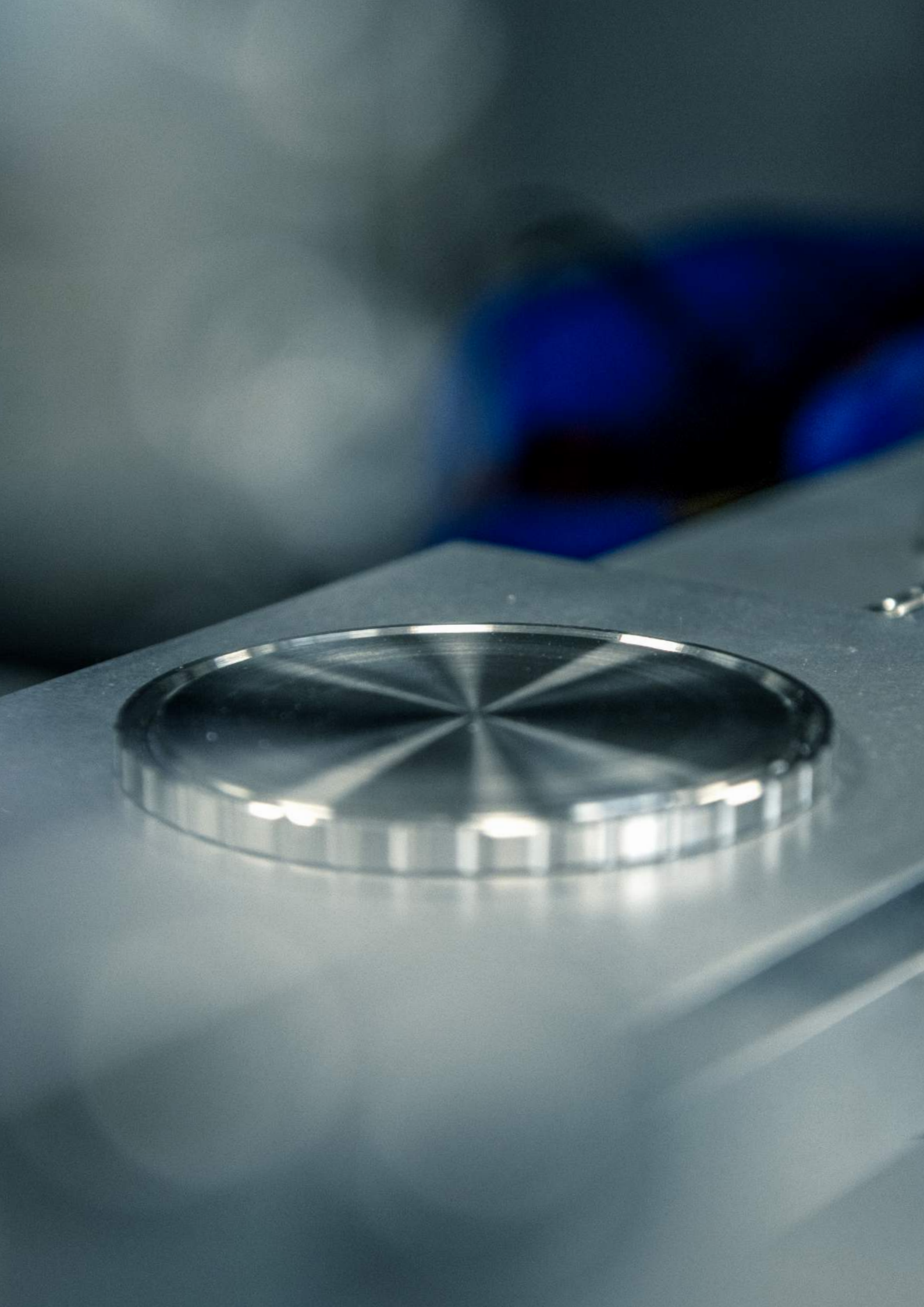

VISCOMETERS AND GELTIMERS

- 8 B-ONE PLUS
- 10 FIRST PLUS
- 12 FIRST PRO
- 14 FIRST PRODIG
- 16 FIRST PRODIG CP 1000
- 18 RM 100 PLUS
- 20 RM 100 CP 1000 PLUS
- 22 RM 100 CP 2000 PLUS
- 24 GT-300 PLUS
- 26 GT-300 PRODIG

B-ONE PLUS

The economical solution
for your viscosity
measurements



Intuitive and powerful, the new B-ONE PLUS will surprise you with its extended measuring range in LR version or with its optional temperature sensor.

FEATURES AND BENEFITS

- Direct measure with time to stop.
- User and locked mode.
- Data recording and USB transfer.
- Torque gage on display.
- External temperature probe (option).
- Display of viscosity limits according to mobile and speed.

WHAT'S INCLUDED WITH DEVICE ?

(according to part number)

- 4 Spindles LV or 6 spindles RV (p75).
or Krebs spindle KU 1-10 (p77).
- 1 Standard stand or rack stand (p68).
- 1 Touch screen stylus.
- 1 User manual.
- 1 Calibration and checking certificate.
- 1 Microfiber cloth.

AVAILABLE INSTRUMENTS

Reference	Designation	Viscosity range (mPa.s)
N600000	B-ONE PLUS VISCOMETER WITH SPINDLES RV-2 TO RV-7 (with standard stand)	200(33*) to 240M
N600200	B-ONE PLUS VISCOMETER WITH SPINDLE KU 1-10 (with standard stand)	40 to 140KU
N600009	B-ONE PLUS VISCOMETER WITH SPINDLES RV-2 TO RV-7 (with rack stand)	200(33*) to 240M
N600300	B-ONE PLUS LR VISCOMETER WITH SPINDLES LV-1 TO LV-4 (with standard stand)	15(1*) to 22M
N600309	B-ONE PLUS LR VISCOMETER WITH SPINDLES LV-1 TO LV-4 (with rack stand)	15(1*) to 22M

(*) Can reach 1 mPa.s (LR) & 33 mPa.s (HR/Standard) with MS ULV (p.78). Not included.

B-ONE PLUS

SPECIFICATIONS

Type of instrument

Rotating springless viscometer with 7" Touch screen

Rotation speeds

Unlimited number of speeds between 0.1 and 250 rpm

Torque range

Standard Version: 0.05 to 13 mNm

LR version: 0.005 to 0.8 mNm

Accuracy

+/- 1 % of the full scale

Repeatability

+/- 0,2 %

Display

Viscosity (cP/Poises or mPa.s / Pa.s)

Speed – Shear rate - Torque - %- Shear stress - Time -
Temperature (in option)

Norms

ASTM : D115 ; D789 ; D1076 ; D1084 ; D1337 ;
D1338 ; D1417; D1439 ; D1824 ; D2196 ; D2243 ;
D2364 ; D2556 ; D3288 ; D3468 ; D3716 ; D3730 ;
D3794 ; D4016 ; D4143 ; D4878 ; D4889 ; D5324 ;
D5400 ; D6279 ; D6577 ; D7394 ; D8020 ; E2975 ;
F1607 ; BS 5350 ; DIN 2555 ; 3219 ; 52007-1 ; 53019-1;
54453 ; EN 302-7 ; 2555 ; 3219 ; 10301 ; 12092 ;
12802 ; 15425 ; 15564 ; ISO 1652 ; 2555 ; 2884-2 ;
3219 ; 10364-12

Languages

French/English/Russian/Spanish/Turkish/German

Supply voltage

90-240 VAC 50/60 Hz

Connection

USB port

Dimensions and weight

Head: D180 x H230 x W130 mm

Aluminium stand: L280 x W200 x H30 mm

Stainless steel rod: Length 500 mm

Weight: 6.7 kg



Ref. N600200
B-ONE PLUS
+ KU 1-10

COMPATIBLES
MEASURING SYSTEMS

MS-RV (p75), MS-LV (p75), MS-BV (p76),
MS-VANES (p77), MS-KREBS (p77),
MS-SV (79), MS-ULV (78), MS-DIN (p72).

COMPATIBLES
TEMPERATURE CONTROLS

EVA LR (p60), EVA MS DIN (p58),
RT-1 PLUS (p61).

OPTIONS & ACCESSORIES +

- Carrying case (p68).
- External temperature probe -50°C to +300°C (p69).
- HELIPRO stand (p66).
- Barcode reader with stand and cable (p68).
- Bayonet spindle rack (p69).
- Touch screen protector (p68).
- Viscosity standards oil (p69).
- Small volume package (p67).
- THERMOCELL package (p61).

FIRST PLUS

More than just a simple viscosity measurement



With its expanded possibilities and increased modularity, the FIRST PLUS will be the ideal tool for your application whether you use it alone or with its software.

FEATURES AND BENEFITS

- Direct measure with time to stop.
- User and locked mode.
- Data recording and USB transfer.
- Torque gage on display.
- Integrated temperature probe.
- Printer connection.
- Compatible with RheoTex software.
- Display of viscosity limits according to mobile and speed.

WHAT'S INCLUDED WITH DEVICE ?

(according to part number)

- 4 Spindles LV or 6 spindles RV (p75).
- 1 Integrated temperature probe.
- 1 Standard stand or rack stand (p68).
- 1 Touch screen stylus.
- 1 User manual.
- 1 Calibration and checking certificate.
- 1 Microfiber cloth.

AVAILABLE INSTRUMENTS

Reference	Designation	Viscosity range (mPa.s)
N700700	FIRST PLUS VISCOMETER WITH SPINDLE RV-2 TO RV-7 (with standard stand)	200(33*) to 240M
N700709	FIRST PLUS VISCOMETER WITH SPINDLE RV-2 TO RV-7 (with rack stand)	200(33*) to 240M
N700300	FIRST PLUS LR VISCOMETER WITH SPINDLE LV-1 TO LV-4 (with standard stand)	15(1*) to 22M
N700009	FIRST PLUS LR VISCOMETER WITH SPINDLE LV-1 TO LV-4 (with rack stand)	15(1*) to 22M

(*) Can reach 1 mPa.s (LR) & 33 mPa.s (HR/Standard) with MS ULV (p.78). Not included.

FIRST PLUS

SPECIFICATIONS

Type of instrument

Rotating springless viscometer with 7" Touch screen

Rotation speeds

Unlimited number of speeds between 0.1 and 250 rpm

Torque range

Standard Version: 0.05 to 13 mNm

LR version: 0.005 to 0.8 mNm

Temperature Probe

Equipped with a PT100 sensor which indicates temperatures between -50°C to +300°C

Accuracy

+/- 1 % of the full scale

Repeatability

+/- 0,2 %

Display

Viscosity (cP/Poises or mPa.s / Pa.s)

Speed – Shear rate – Torque – %- Shear stress - Time – Temperature

Norms

ASTM : D115 ; D789 ; D1076 ; D1084 ; D1337 ;
 D1338 ; D1417 ; D1439 ; D1824 ; D2196 ; D2243 ;
 D2364 ; D2556 ; D3288 ; D3468 ; D3716 ; D3730 ;
 D3794 ; D4016 ; D4143 ; D4878 ; D4889 ; D5324
 ; D5400 ; D6279 ; D6577 ; D7394 ; D8020 ; E2975
 ; F1607 ; BS 5350 ; DIN 2555 ; 3219 ; 52007-1 ;
 53019-1 ; 54453 ; EN 302-7 ; 2555 ; 3219 ; 10301 ;
 12092 ; 12802 ; 15425 ; 15564 ; ISO 1652 ; 2555 ;
 2884-2 ; 3219 ; 10364-12

Languages

French/English/Russian/Spanish/Turkish/German

Supply voltage

90-240 VAC 50/60 Hz

Analog output

4 – 20 mA

PC connections

RS232 Port and USB

Printer connection

USB Host Port -

Compatible PCL/5

Dimensions and weight

Head: D180 x H230 x W130 mm

Aluminium stand: L280 x W200 x H30 mm

Stainless steel rod: Length 500 mm

Weight: 6.7 kg

COMPATIBLES

MEASURING SYSTEMS

MS-RV (p75), MS-LV (p75), MS-BV (p76),
 MS-VANES (p77), MS-KREBS (p77),
 MS-SV (p79), MS-ULV (p78), MS-DIN (p72).

COMPATIBLES

TEMPERATURE CONTROLS

EVA LR (p60), EVA MS DIN (p58),
 RT-1 PLUS (p61).

OPTIONS & ACCESSORIES



- Carrying case (p68).
- External temperature probe -50°C to +300°C (p69).
- HELIPRO stand (p66).
- Barcode reader with stand and cable (p68).
- Bayonet spindle rack (p69).
- Touch screen protector (p68).
- Viscosity standards oil (p69).
- Dymo printer (p68).
- Small volume package (p67).
- THERMOCELL package (p61).
- RheoTex software (p64-65).

FIRST PRO

**Programmed
for your measurements**



FIRST PRO has the same enhanced programming capabilities as the most complete instruments to maximize the repeatability of your measurements.

FEATURES AND BENEFITS

- Programming and recording method.
- Direct measure with time to stop.
- User and locked mode.
- Data recording and USB transfer.
- Torque gage on display.
- Integrated temperature probe.
- Printer connection.
- Compatible with RheoTex software.
- Display of viscosity limits according to mobile and speed.

WHAT'S INCLUDED WITH DEVICE ?

(according to part number)

- 4 Spindles LV or 6 spindles RV (p75).
- 1 Integrated temperature probe.
- 1 Standard stand or rack stand (p68).
- 1 Touch screen stylus.
- 1 User manual.
- 1 Calibration and checking certificate.
- 1 Microfiber cloth.

AVAILABLE INSTRUMENTS

Reference	Designation	Viscosity range (mPa.s)
N702700	FIRST PRO VISCOMETER WITH SPINDLES RV-2 TO RV-7 (with standard stand)	200(33*) to 240M
N702709	FIRST PRO VISCOMETER WITH SPINDLES RV-2 TO RV-7 (with rack stand)	200(33*) to 240M
N702300	FIRST PRO LR VISCOMETER WITH SPINDLES LV-1 TO LV-4 (with standard stand)	15(1*) to 22M
N702309	FIRST PRO LR VISCOMETER WITH SPINDLES LV-1 TO LV-4 (with rack stand)	15(1*) to 22M

(*) Can reach 1 mPa.s (LR) & 33 mPa.s (HR/Standard) with MS ULV (p.78). Not included.

FIRST PRO

SPECIFICATIONS

Type of instrument

Rotating springless viscometer with 7" Touch screen

Rotation speeds

Unlimited number of speeds between 0.1 and 250 rpm

Torque range

Standard Version: 0.05 to 13 mNm

LR Version: 0.005 to 0.8 mNm

Temperature Probe

Equipped with a PT100 sensor which indicates temperatures between -50°C to +300°C

Accuracy

+/- 1 % of the full scale

Repeatability

+/- 0,2 %

Display

Viscosity (cP/Poises or mPa.s / Pa.s)

Speed – Shear rate – Torque – %- Shear stress - Time – Temperature

Norms

ASTM : D115 ; D789 ; D1076 ; D1084 ; D1337 ;
 D1338 ; D1417 ; D1439 ; D1824 ; D2196 ; D2243 ;
 D2364 ; D2556 ; D3288 ; D3468 ; D3716 ; D3730 ;
 D3794 ; D4016 ; D4143 ; D4878 ; D4889 ; D5324 ;
 D5400 ; D6279 ; D6577 ; D7394 ; D8020 ; E2975 ;
 F1607 ; BS 5350 ; DIN 2555 ; 3219 ; 52007-1 ; 53019-
 1 ; 54453 ; EN 302-7 ; 2555 ; 3219 ; 10301 ; 12092 ;
 12802 ; 15425 ; 15564 ; ISO 1652 ; 2555 ; 2884-2 ;
 3219 ; 10364-12

Languages

French/English/Russian/Spanish/Turkish/German

Supply voltage

90-240 VAC 50/60 Hz

Analog output

4 – 20 mA

PC connections

RS232 Port and USB

Printer connectionUSB Host Port -
Compatible PCL/5**Dimensions and weight**

Head: D180 x H230 x W130 mm

Aluminium stand: L280 x W200 x H30 mm

Stainless steel rod: Length 500 mm

Weight: 6.7 kg

COMPATIBLES
MEASURING SYSTEMS

MS-RV (p75), MS-LV (p75), MS-BV (p76),
 MS-VANES (p77), MS-KREBS (p77),
 MS-SV (p79), MS-ULV (p78), MS-DIN (p72).

COMPATIBLES
TEMPERATURE CONTROLS

EVA LR (p60), EVA MS DIN (p58),
 RT-1 PLUS (p61).

OPTIONS & ACCESSORIES +

- Carrying case (p68).
- External temperature probe -50°C to +300°C (p69).
- HELIPRO stand (p66)
- Barcode reader with stand and cable (p68).
- Bayonet spindle rack (p69).
- Touch screen protector (p68).
- Viscosity standards oil (p69).
- Dymo printer (p68).
- Small volume package (p67).
- THERMOCELL package (p61).
- RheoTex software (p64-65).

FIRST PRODIG

**The solution
to your most
exacting methods.**



The viscometer with a 7 '' touch screen allows you to create and save your measurement methods, display results or curves, analyse your data, print reports, manage users and protect data.

FEATURES AND BENEFITS

- Speed or shear rate control.
- Programming and recording method.
- Constant, step by step or ramp methods.
- Direct curve on display.
- Direct analysis with regression.
- Direct report editing.
- Direct measure with time to stop.
- User and locked mode.
- Data recording and USB transfer.
- Torque gage on display.
- Integrated temperature probe.
- Printer connection.
- Compatible with RheoTex software.
- Display of viscosity limits according to mobile and speed.

WHAT'S INCLUDED WITH DEVICE ?

(according to part number)

- 4 Spindles LV or 6 spindles RV(p75).
- 1 Integrated temperature probe.
- 1 Standard stand or rack stand(p68).
- 1 Touch screen stylus.
- 1 User manual.
- 1 Calibration and checking certificate.
- 1 Microfiber cloth.

AVAILABLE INSTRUMENTS

Reference	Designation	Viscosity range (mPa.s)
N707700	FIRST PRODIG VISCOMETER WITH SPINDLES RV-2 TO RV-7 (with standard stand)	200(33*) to 240M
N707709	FIRST PRODIG VISCOMETER WITH SPINDLES RV-2 TO RV-7 (with rack stand)	200(33*) to 240M
N707300	FIRST PRODIG LR VISCOMETER WITH SPINDLES LV-1 TO LV-4 (with standard stand)	15(1*) to 22M
N707309	FIRST PRODIG LR VISCOMETER WITH SPINDLES LV-1 TO LV-4 (with rack stand)	15(1*) to 22M

(*) Can reach 1 mPa.s (LR) & 33 mPa.s (HR/Standard) with MS ULV (p.78). Not included.

FIRST PRODIG

SPECIFICATIONS

Type of instrument

Rotating springless viscometer with 7" Touch screen

Rotation speeds

Unlimited number of speeds between 0.1 and 250 rpm

Torque rangeStandard Version: 0.05 to 13 mNm
LR version: 0.005 to 0.8 mNm**Temperature Probe**

Equipped with a PT100 sensor which indicates temperatures between -50°C to +300°C

Accuracy

+/- 1 % of the full scale

Repeatability

+/- 0,2 %

DisplayViscosity (cP/Poises or mPa.s / Pa.s)
Speed – Shear rate – Torque – %- Shear stress - Time – Temperature**Norms**ASTM : D115 ; D789 ; D1076 ; D1084 ; D1337 ;
D1338 ; D1417 ; D1439 ; D1824 ; D2196 ; D2243 ;
D2364 ; D2556 ; D3288 ; D3468 ; D3716 ; D3730 ;
D3794 ; D4016 ; D4143 ; D4878 ; D4889 ; D5324 ;
D5400 ; D6279 ; D6577 ; D7394 ; D8020 ; E2975 ;
F1607 ; BS 5350 ; DIN 2555 ; 3219 ; 52007-1 ; 53019-
1 ; 54453 ; EN 302-7 ; 2555 ; 3219 ; 10301 ; 12092 ;
12802 ; 15425 ; 15564 ; ISO 1652 ; 2555 ; 2884-2 ;
3219 ; 10364-12**Languages**

French/English/Turkish/German

Supply voltage

90-240 VAC 50/60 Hz

Analog output

4 – 20 mA

PC connections

RS232 Port and USB

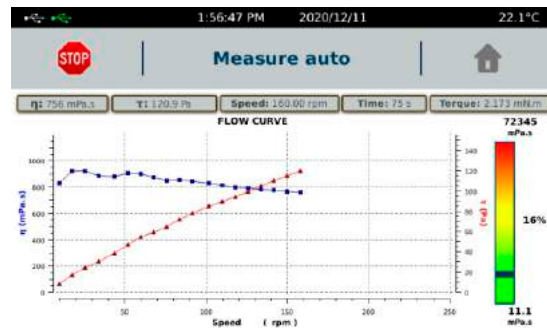
Printer connectionsUSB Host Port -
Compatible PCL/5**Dimensions and weight**Head: D160 x H270 x W200 mm
Aluminium stand: L280 x W200 x H30 mm
Stainless steel rod: Length 500 mm
Weight: 6.7 kgCOMPATIBLES
MEASURING SYSTEMSMS-RV (p75), MS-LV (p75), MS-BV (p76),
MS-VANES (p77), MS-KREBS (p77),
MS-SV (p79), MS-ULV (p78), MS-DIN (p72).COMPATIBLES
TEMPERATURE CONTROLSEVA LR (p60), EVA MS DIN (p58),
RT-1 PLUS (p61).

OPTIONS & ACCESSORIES +

- Carrying case (p68).
- External temperature probe -50°C to +300°C (p69).
- HELIPRO stand (p66).
- Barcode reader with stand and cable (p68).
- Bayonet spindle rack (p69).
- Touch screen protector (p68).
- Viscosity standards oil (p69).
- Dymo printer (p68).
- Small volume package (p67).
- THERMOCELL package (p61).
- RheoTex software (p64-65).

FIRST PRODIG CP 1000

**A revolution
for measurements
on low volumes.**



The FIRST PRODIG CP1000 offers unparalleled ease of use and modularity. It incorporates a support for cone-plate measurements. It is perfectly suited to measurements at ambient temperature and offers the possibility to control temperature of the sample when combined with a circulating bath (not included). Its versatility allows it to use other measuring mobiles such as MS-RV, MS KREBS or MS VANE.

FEATURES AND BENEFITS

- Cp1000 stand for cone-plate measurement.
- Quick attachment with AC265 coupling.
- Manual lift for gap adjustment.
- Speed or shear rate control.
- Programming and recording method.
- Constant, step by step or ramp methods.
- Direct curve on display.
- Direct analysis with regression.
- Direct report editing.
- Direct measure with time to stop.
- User and locked mode.
- Data recording and USB transfer.
- Torque gage on display.
- Integrated temperature probe.
- Printer connection.
- Compatible with RheoTex software.
- Display of viscosity limits according to mobile and speed.

WHAT'S INCLUDED WITH DEVICE ?

- 1 Stand with 70mm bottom plate.
- 1 Double rod with stop ring and adjusting gap.
- 2 Silicon pipe (1m).
- 1 Integrated temperature probe.
- 1 Touch screen stylus.
- 1 User manual.
- 1 Calibration and checking certificate.
- 1 Microfiber cloth.

AVAILABLE INSTRUMENT

Reference	Designation	Viscosity range (mPa.s)
N707500	FIRST PRODIG CP1000 VISCOMETER	3 to 800M **

M for million / * Maximum temperature range with circulating bath (not included). / ** According to cone-plate MS CP (p80). Not included.

FIRST PRODIG CP 1000

SPECIFICATIONS

Type of instrument

Rotating springless viscometer with 7" Touch screen

Rotation speeds

Unlimited number of speeds between 0.1 and 250 rpm

Torque range

From 0.05 to 13 mNm

Temperature Probe

Equipped with a PT100 sensor which indicates temperatures between -50°C to +300°C

Accuracy

+/- 1 % of the full scale

Repeatability

+/- 0,2 %

Display

Viscosity (cP/Poises or mPa.s / Pa.s)

Speed – Shear rate – Torque – %- Shear stress - Time – Temperature

Norms

ASTM : D4287 ; BS 3900 ; DIN 3219 ; 52007-1 ; 53019-1 ; 54453 ; ISO 2884; 3219 ; 10364-12

Languages

French/English/Turkish/German

Supply voltage

90-240 VAC 50/60 Hz

Analog output

4 – 20 mA

PC connections

RS232 Port and USB

Printer connection

USB Host Port -
Compatible PCL/5

Dimensions and weight

D320 x H550 x W200 mm

Weight: 14 kg



FIRST PRODIG CP 1000
+ MK-VANE

COMPATIBLES MEASURING SYSTEMS

MS CP (p80), MS-RV (p75)*, MS-VANES (p77)*,
MS-KREBS (p77)*, (* with adaptor Ref. 800146).

OPTIONS & ACCESSORIES



- Barcode reader with stand and cable (p68).
- Touch screen protector (p68).
- Viscosity standards oil (p69).
- Dymo printer (p68).
- RheoTex software (p64-65).
- Protection cover (Ref. 121019).

RM 100 PLUS

Our most
modular viscometer



The RM100 PLUS is the viscometer with largest speed and torque range available on market. Create your methods and store your results in relation with your application.

FEATURES AND BENEFITS

- Speed or shear rate control.
- Huge speed and torque range.
- Direct control of temperature unit.
- Programming and recording method.
- Direct measure with time to stop.
- User and locked mode.
- Data recording and USB transfer.
- Torque gage on display.
- Integrated temperature probe.
- Printer connection.
- Compatible with RheoTex software.
- Display of viscosity limits according to mobile and speed.

WHAT'S INCLUDED WITH DEVICE ?

(according to part number)

- 1 Integrated temperature probe.
- 1 Standard stand or rack stand (p68).
- 1 Touch screen stylus.
- 1 User manual.
- 1 Calibration and checking certificate.
- 1 Microfiber cloth.

AVAILABLE INSTRUMENTS

Reference	Designation	Viscosity range (mPa.s)
N100000	RM 100 PLUS VISCOMETER (with standard stand)	1 to 780M*
N100009	RM 100 PLUS VISCOMETER (with rack stand)	1 to 780M*

M for million / * According to measuring system (p72-79). Not Included.

RM 100 PLUS

SPECIFICATIONS

Type of instrument

Rotating springless viscometer with 7" Touch screen

Rotation speeds

Unlimited number of speeds between 0.1 and 1500 rpm

Torque range

From 0.05 to 30 mNm

Temperature Probe

Equipped with a PT100 sensor which indicates temperatures between -50°C to +300°C

Accuracy

+/- 1 % of the full scale

Repeatability

+/- 0,2%

Display

Viscosity (cP/Poises or mPa.s / Pa.s)

Speed – Shear rate – Torque – %- Shear stress - Time
– Temperature

Norms

ASTM : D115 ; D789 ; D1076 ; D1084 ; D1337 ;
D1338 ; D1417 ; D1439 ; D1824 ; D2196 ; D2243 ;
D2364 ; D2556 ; D3288 ; D3468 ; D3716 ; D3730 ;
D3794 ; D4016 ; D4143 ; D4878 ; D4889 ; D5324 ;
D5400 ; D6279 ; D6577 ; D7394 ; D8020 ; E2975 ;
F1607 ; BS 5350 ; DIN 2555 ; 3219 ; 52007-1 ; 53019-
1 ; 54453 ; EN 302-7 ; 2555 ; 3219 ; 10301 ; 12092
; 12802 ; 15425 ; 15564 ; IOCCC 2000 ; ISO 1652 ;
2555 ; 2884-2 ; 3219 ; 10364-12

Languages

French/English/Russian/Spanish/Turkish/German

Supply voltage

90-240 VAC 50/60 Hz

Analog output

4 - 20 mA

PC connections

RS232 Port and USB

Printer connection

USB Host Port -
Compatible PCL/5

Dimensions and weight

Head: D180 x H230 x W130 mm

Aluminium stand: L280 x W200 x H30 mm

Stainless steel rod: Length 500 mm

Weight: 6.7 kg

COMPATIBLES MEASURING SYSTEMS

MS-RV (p75), MS-LV (p75), MS-BV (p76),
MS-VANES (p77), MS-KREBS (p77), MS-SV (p79),
MS-ULV (p78), MS-DIN (p72), MS-R (p74).

COMPATIBLES TEMPERATURE CONTROLS

EVA LR (p60), EVA MS DIN (p58),
RT-1 PLUS (p61), EVA MS-R (p59).

OPTIONS & ACCESSORIES +

- Carrying case (p68).
- External temperature probe -50°C to +300°C (p69).
- HELIPRO stand (p66).
- Barcode reader with stand and cable (p68).
- Bayonet spindle rack (p69).
- Touch screen protector (p68).
- Viscosity standards oil (p69).
- Dymo printer (p68).
- Small volume package (p67).
- THERMOCELL package (p61).
- RheoTex software (p64-65).

RM 100 CP 1000 PLUS

Cone plate viscometer for ICI method



Equipped with a fluid circulation for temperature control (bath not included), the RM100 CP1000 PLUS will allow you to perform cone-plate and beaker measurements using the MS RV, MS VANE or MS KREBS mobiles.

FEATURES AND BENEFITS

- Cp1000 stand for cone plate measurement.
- Quick attachment with AC265 coupling.
- Manual lift for gap adjustment.
- Speed or shear rate control.
- Programming and recording method.
- Direct measure with time to stop.
- User and locked mode.
- Data recording and USB transfer.
- Torque gage on display.
- Integrated temperature probe.
- Printer connection.
- Compatible with RheoTex software.
- Display of viscosity limits according to mobile and speed.

WHAT'S INCLUDED WITH DEVICE ?

- 1 Stand with 70mm bottom plate.
- 1 Double rod with stop ring and adjusting gap.
- 2 Silicon pipe(1m).
- 1 Integrated temperature probe.
- 1 Touch screen stylus.
- 1 User manual.
- 1 Calibration and checking certificate.
- 1 Microfiber cloth.

AVAILABLE INSTRUMENT

Reference	Designation	Viscosity range (mPa.s)
N100365	RM 100 CP1000 CONE PLATE VISCOMETER	1 to 1900M **

M for million / * Maximum temperature range with water circulating bath (not included). / ** According to MS CP spindle (p80) not included.

RM 100 CP 1000 PLUS

SPECIFICATIONS

Type of instrument

Rotating springless viscometer with 7" Touch screen

Rotation speeds

Unlimited number of speeds between 0.1 and 1500 rpm

Torque range

From 0.05 to 30 mNm

Temperature Probe

Equipped with a PT100 sensor which indicates temperatures between -50°C to +300°C

Accuracy

+/- 1 % of the full scale

Repeatability

+/- 0,2 %

Display

Viscosity (cP/Poises or mPa.s / Pa.s)

Speed – Shear rate – Torque – %- Shear stress - Time – Temperature

Norms

ASTM : D4287 ; BS 3900 ; DIN 3219 ; 52007-1 ; 53019-1 ; 54453 ; ISO 2884 ; 3219 ; 10364-12

Languages

French/English/Russian/Spanish/Turkish/German

Supply voltage

90-240 VAC 50/60 Hz

Analog output

4 – 20 mA

PC connections

RS232 Port and USB

Printer connection

USB Host Port -
Compatible PCL/5

Dimensions and weight

D320 x H550 x W200 mm

Weight: 14 kg

COMPATIBLES MEASURING SYSTEMS

MS CP (p80), MS-RV (p75)*, MS-VANES (p77)*,
MS-KREBS (p77)*, (* with adaptor Ref. 800146).



RM 100 CP 1000
+ MS-KREBS

OPTIONS & ACCESSORIES +

- Barcode reader with stand and cable (p68).
- Touch screen protector (p68).
- Viscosity standards oil (p69).
- Dymo printer (p68).
- RheoTex software (p64-65).
- Protection cover (Ref. 121019).

RM 100 CP 2000 PLUS

The viscometer dedicated
for cone-plate
measurements



Cone-plate measuring systems are adapted for samples in limited quantities and difficult to clean. With maximum shear gradients up to 20,000 s⁻¹, the RM100 CP2000 PLUS will fit all your applications.

FEATURES AND BENEFITS

- For cone plate measurement.
- Quick attachment with AC265 coupling.
- Speed or shear rate control.
- Huge speed and torque range.
- Direct control of temperature unit.
- Programming and recording method.
- Direct measure with time to stop.
- User and locked mode.
- Data recording and USB transfer.
- Torque gage on display.
- Integrated temperature probe.
- Printer connection.
- Compatible with RheoTex software.
- Display of viscosity limits according to mobile and speed.

WHAT'S INCLUDED WITH DEVICE ?

(according to part number)

- 1 Temperature unit with 70mm bottom plate.
- 1 Touch screen stylus.
- 1 User manual.
- 1 Calibration and checking certificate.
- 1 Microfiber cloth.

AVAILABLE INSTRUMENTS

Reference	Designation	Viscosity range (mPa.s)
N170000	RM 100 CP2000 PLUS VISCOMETER AIR PELTIER (+10°C to +70°C)	1 to 1900M (according to spindle MS CP p80)
N170100	RM 100 CP2000 PLUS VISCOMETER AIR PELTIER (+10°C to +70°C) WITH PROGRAMMER*	
N170200	RM 100 CP2000 PLUS VISCOMETER LIQUID PELTIER** (-20°C to +100°C)	
N170300	RM 100 CP2000 PLUS VISCOMETER LIQUID PELTIER** (-20°C to +100°C) WITH PROGRAMMER*	
N170400	RM 100 CP2000 PLUS VISCOMETER (Room T°C to +300°C)	
N170500	RM 100 CP2000 PLUS VISCOMETER (Room T°C to +300°C) WITH PROGRAMMER*	
N170800	RM 100 CP2000 PLUS VISCOMETER AIR PELTIER (0°C to +150°C)	
N170900	RM 100 CP2000 PLUS VISCOMETER AIR PELTIER (0°C to +150°C) WITH PROGRAMMER*	

M for million / * Allow temperature setting by measuring head or RheoTex software. / ** Water circulating bath required. Not included.

RM 100 CP 2000 PLUS

SPECIFICATIONS

Type of instrument

Rotating springless viscometer with 7" Touch screen

Rotation speeds

Unlimited number of speeds between 0.1 and 1500 rpm

Torque range

From 0.05 to 30 mNm

Temperature Probe

Equipped with a PT100 sensor which indicates temperatures between -50°C to +300°C

Accuracy

+/- 1 % of the full scale

Repeatability

+/- 0,2 %

Display

Viscosity (cP/Poises or mPa.s / Pa.s)

Speed – Shear rate – Torque – %- Shear stress - Time – Temperature

Norms

ASTM : D4287 ; BS 3900 ; DIN 3219 ; 52007-1 ; 53019-1 ; 54453 ; ISO 2884; 3219 ; 10364-12

Languages

French/English/Russian/Spanish/Turkish/German

Supply voltage

90-240 VAC 50/60 Hz

Analog output

4 – 20 mA

PC connections

RS232 Port and USB

Printer connection

USB Host Port -
Compatible PCL/5

Dimensions and weight

D610 x H700 x W340 mm

Weight: 22 kg

COMPATIBLES MEASURING SYSTEMS

MS-CP (p80).



BARCODE READER

OPTIONS & ACCESSORIES



- Barcode reader with stand and cable (p68).
- Touch screen protector (p68).
- Viscosity standards oil (p69).
- Dymo printer (p68).
- RheoTex software (p64-65).
- Protection cover (Ref. 121019).

GT-300 PLUS

The ideal instrument
for your **curing time**



The GT300 is a «Gel Timer» to measure all curing times of your products. Combined with disposable measuring systems and temperature control, it adapts to all your expectations for a very competitive cost per measurement.

FEATURES AND BENEFITS

- RheoTex software included.
- Direct control of temperature unit.
- Measure with disposable hooks and cups.
- Sample temperature probe (option).
- Low sample volume.
- Temperature ramp available.
- Display of viscosity limits according to mobile and speed.

WHAT'S INCLUDED WITH DEVICE ?

(according to part number)

- 1 Holder for disposable hook.
- 1 Integrated temperature unit (Except item Ref. N125000).
- 1 RheoTex software.
- 1 Touch screen stylus.
- 1 User manual.
- 1 Calibration and checking certificate.
- 1 Microfiber cloth.

AVAILABLE INSTRUMENTS

Reference	Designation
N125000	GT300 GEL TIMER Room T°C
N125100	GT300 GEL TIMER (Room T°C to +300°C)
N125200	GT300 GEL TIMER (Room T°C to +300°C) WITH PROGRAMMER*
N125400	GT300 GEL TIMER AIR PELTIER (+15°C to + 60°C)
N125500	GT300 GEL TIMER AIR PELTIER (+15°C to + 60°C) WITH PROGRAMMER*
N125600	GT300 GEL TIMER AIR PELTIER (0°C to + 150°C)
N125700	GT300 GEL TIMER AIR PELTIER (0°C to + 150°C) WITH PROGRAMMER*

* Allow temperature setting by measuring head or RheoTex software.

GT-300 PLUS

SPECIFICATIONS

Type of instrument

Rotating springless viscometer with 7" Touch screen

Rotation speeds

Unlimited number of speeds between 0.1 and 1500 rpm

Torque range

From 0.05 to 30 mNm

Temperature Probe

Equipped with a PT100 sensor which indicates temperatures between -50°C to +300°C

Accuracy

+/- 1 % of the full scale

Repeatability

+/- 0,2 %

Display

Viscosity (cP/Poises or mPa.s / Pa.s)

Speed – Shear rate – Torque – %- Shear stress - Time

– Temperature

Languages

French/English/Russian/Spanish/Turkish/German

Supply voltage

90-240 VAC 50/60 Hz

Analog output

4 - 20 mA

PC connections

RS232 Port and USB

Printer connections

USB Host Port -

Compatible PCL/5

Dimensions and weight

GT300 without temperature unit:

D320 x H650 x W200 mm. Weight: 14 kg

GT300 with temperature unit:

D610 x H700 x W340 mm. Weight: 22 kg

Disposable cup
(aluminium)
(by 100)
Ref. 700011



Disposable hook
(stainless steel)
(Vol. 50-80mL)
(by 100)
Ref. 700010



Disposable hook
(steel)
(Vol. 35-50mL)
(by 100)
Ref. 700040



Ref. N125000
GT-300 GEL TIMER
ROOM T°

OPTIONS & ACCESSORIES +

- Barcode reader with stand and cable (p68).
- Touch screen protector (p68).
- Breakable Thermocouple 5 m type K (Complete kit with connector (Ref. 000645).
- 100 Disposable cups aluminium (Ref. 700011).
- 100 Disposable steel hooks low volume (Ref. 700040).
- 100 Disposable stainless steel hooks (Ref. 700010).
- Protection cover (Ref. 310119).

GT-300 PRODIG

Measure **your Gel Time**
on **one click**



The GT300 PRODIG measures your gel time, show curves, analyse your data and print reports. Autonomy and user-friendly, it benefits to GT300 performances with ergonomic innovations.

FEATURES AND BENEFITS

- Programming and recording method.
- Direct curve on display.
- Direct Gel time analysis.
- Direct report editing.
- Direct control of temperature unit.
- Measure with disposable hooks and cups.
- Sample temperature probe (option).
- Low sample volume.
- Temperature ramp available.
- Display of viscosity limits according to mobile and speed.

WHAT'S INCLUDED WITH DEVICE ?

(according to part number)

- 1 Holder for disposable hook.
- 1 Integrated temperature unit (Except item Ref. N129000).
- 1 Touch screen stylus.
- 1 User manual.
- 1 Calibration and checking certificate.
- 1 Microfiber cloth.

AVAILABLE INSTRUMENTS

Reference	Designation
N129000	GT300 PRODIG GEL TIMER Room T°C
N129100	GT300 PRODIG GEL TIMER (Room T°C to +300°C)
N129200	GT300 PRODIG GEL TIMER (Room T°C to +300°C) WITH PROGRAMMER*
N129400	GT300 PRODIG GEL TIMER AIR PELTIER (+15°C to +60°C)
N129500	GT300 PRODIG GEL TIMER AIR PELTIER (+15°C to +60°C) WITH PROGRAMMER*
N129600	GT300 PRODIG GEL TIMER AIR PELTIER (0°C to +150°C)
N129700	GT300 PRODIG GEL TIMER AIR PELTIER (0°C to +150°C) WITH PROGRAMMER*

* Allow temperature setting by measuring head or RheoTex software.

GT-300 PRODIG

SPECIFICATIONS

Type of instrument

Rotating springless viscometer with 7" Touch screen

Rotation speeds

Unlimited number of speeds between 0.1 and 1500 rpm

Torque range

From 0.05 to 30 mNm

Temperature Probe

Equipped with a PT100 sensor which indicates temperatures between -50°C to +300°C

Accuracy

+/- 1 % of the full scale

Repeatability

+/- 0,2 %

Display

Viscosity (cP/Poises or mPa.s / Pa.s)
Speed – Shear rate – Torque – % - Shear stress - Time – Temperature

Languages

French/English/Turkish/German

Supply voltage

90-240 VAC 50/60 Hz

Analog output

4 - 20 mA

PC connections

RS232 Port and USB

Printer connection

USB Host Port -
Compatible PCL/5

Dimensions and weight

GT300 PRODIG without temperature unit:
D320 x H650 x W200 mm. Weight: 14 kg

GT300 PRODIG with temperature unit:
D610 x H700 x W340 mm. Weight: 22 kg

Disposable cup
(aluminium)
(by 100)
Ref. 700011



Disposable hook
(stainless steel)
(Vol. 50-80mL)
(by 100)
Ref. 700010



Disposable hook
(steel)
(Vol. 35-50mL)
(by 100)
Ref. 700040

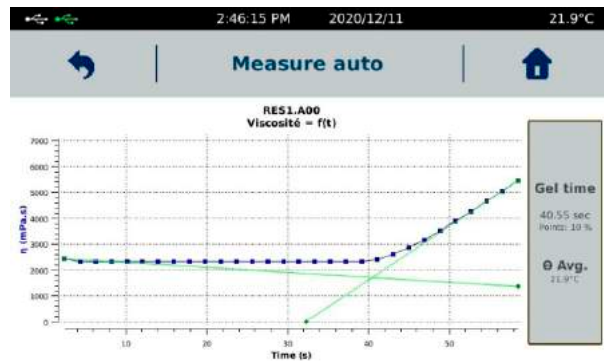

OPTIONS & ACCESSORIES +

- Barcode reader with stand and cable (p68).
- Touch screen protector (p68).
- Breakable Thermocouple 5 m type K (Complete kit with connector (Ref. 000645).
- 100 Disposable cups aluminium (Ref. 700011).
- 100 Disposable steel hooks low volume (Ref. 700040).
- 100 Disposable stainless steel hooks (Ref. 700010).
- RheoTex software (p64-65).
- Protection cover (Ref. 310119).



PORTABLES AND INDUSTRIALS VISCOMETERS

- 30 PORTABLE B-ONE
- 32 PORTABLE RM 100
- 34 RM 100 i
- 36 RM 100 L

PORTABLE B-ONE

This viscometer
follow you
everywhere



The B-ONE PORTABLE is the ideal tool for your viscosity measurements in the workshop, production area, delivery area or outside. With one hour of battery life, it will optimize your control times and flexibility.

FEATURES AND BENEFITS

- Autonomy more than one hour.
- Charge indicator.
- Direct measure with time to stop.
- Usable with standard or rack stand (option).
- User and locked mode.
- Data recording and USB transfer.
- Torque gage on display.
- Display of viscosity limits according to mobile and speed.

WHAT'S INCLUDED WITH DEVICE ?

- 1 Carrying case (p68).
- 1 Touch screen stylus.
- 1 User manual.
- 1 Calibration and checking certificate.
- 1 Microfiber cloth.
- 1 Harness.

AVAILABLE INSTRUMENT

Reference	Designation	Viscosity range (mPa.s)
T600700	B-ONE PORTABLE VISCOMETER	200(15**) to 240M*

M for million / * With MS-RV (RV2 to RV7) (p75). Not included. / ** Can reach 15 mPa.s with MS BV (p76). Not included.

PORTABLE B-ONE

SPECIFICATIONS

Type of instrument

Rotating springless viscometer with 7" Touch screen

Rotation speeds

Unlimited number of speeds between 0.3 and 250 rpm

Torque range

From 0.05 to 13 mNm

Accuracy

+/- 1 % of the full scale

Repeatability

+/- 0,2 %

Display

Viscosity (cP/Poises or mPa.s / Pa.s)

Speed – Shear rate – Torque – %- Shear stress – Time

Norms

ASTM : D115 ; D789 ; D1076 ; D1084 ; D1337 ;
D1338 ; D1417 ; D1439 ; D1824 ; D2196 ; D2243 ;
D2364 ; D2556 ; D3288 ; D3468 ; D3716 ; D3730 ;
D3794 ; D4016 ; D4143 ; D4878 ; D4889 ; D5324 ;
D5400 ; D6279 ; D6577 ; D7394 ; D8020 ; E2975 ;
F1607 ; **BS** 5350 ; **DIN** 2555; 52007-1 ; **EN** 302-7 ;
2555 ; 3219 ; 10301 ; 12092 ; 12802 ; 15425 ; 15564 ;
ISO 1652 ; 2555 ; 2884-2 ; 10364-12

Languages

French/English/Russian/Spanish/Turkish/German

Supply voltage

90-240 VAC 50/60 Hz

Dimensions et poids

Head : Ø 90 mm

Box D60 x H260 x W120

Weight: 2 kg

COMPATIBLES MEASURING SYSTEMS

MS-RV (p75), **MS-LV** (p75), **MS-BV** (p76),
MS-VANES (p77), **MS-KREBS** (p77),
MS-SV (p79), **MS-ULV** (p78), **MS-DIN** (p72).

COMPATIBLES TEMPERATURE CONTROLS

EVA LR (p60), **EVA MS DIN** (p59),
RT-1 PLUS (p61).

OPTIONS & ACCESSORIES +

- Standard or rack stand (p68).
- HELIPRO stand (p66).
- Small volume package (p67).
- THERMOCELL package (p61).
- Bayonet spindle rack (p69).
- Barcode reader with stand and cable (p68).
- Touch screen protector (p68).
- Viscosity standards oil (p69)

PORTABLE RM 100

Your expertise
closer to
the product



No matter where, the RM100 PORTABLE allows you to bring your viscosity measurement methods where your lab can not operate. With programming, memorization, temperature measurement and all measuring systems, all your expertise is moving!

FEATURES AND BENEFITS

- Autonomy more than one hour.
- Charge indicator.
- Huge speed and torque range.
- Usable with standard or rack stand (option).
- Programming and recording method.
- Direct measure with time to stop.
- User and locked mode.
- Data recording and USB transfer.
- Torque gage on display.
- Integrated temperature probe.
- Printer connection.
- Compatible with RheoTex software.
- Display of viscosity limits according to mobile and speed.

WHAT'S INCLUDED WITH DEVICE ?

- 1 Integrated temperature probe .
- 1 Carrying case (p68).
- 1 Touch screen stylus.
- 1 User manual.
- 1 Calibration and checking certificate.
- 1 Microfiber cloth.
- 1 Harness.

AVAILABLE INSTRUMENT

Reference	Designation	Viscosity range (mPa.s)
T100100	RM100 PORTABLE VISCOMETER	200(1**) to 240M*

M for million / * With MS-RV (RV2 to RV7) (p75). Not included. / ** Can reach 1 mPa.s with MS DIN19 (p72). Not included.

PORTABLE RM 100

SPECIFICATIONS

Type of instrument

Rotating springless viscometer with 7" Touch screen

Rotation speeds

Unlimited number of speeds between 0.3 and 1500 rpm

Torque range

From 0.05 to 30 mNm

Temperature Probe

Equipped with a PT100 sensor which indicates temperatures between -50°C to +300°C

Accuracy

+/- 1 % of the full scale

Repeatability

+/- 0,2 %

Display

Viscosity (cP/Poises or mPa.s / Pa.s)

Speed – Shear rate – Torque – %- Shear stress - Time
– Temperature

Norms

ASTM : D115 ; D789 ; D1076 ; D1084 ; D1337 ;
D1338 ; D1417 ; D1439 ; D1824 ; D2196 ; D2243 ;
D2364 ; D2556 ; D3288 ; D3468 ; D3716 ; D3730 ;
D3794 ; D4016 ; D4143 ; D4878 ; D4889 ; D5324
; D5400 ; D6279 ; D6577 ; D7394 ; D8020 ; E2975
; F1607 ; **BS** 5350 ; **DIN** 2555 ; 3219 ; 52007-1 ;
53019-1 ; 54453 ; **EN** 302-7 ; 2555 ; 3219 ; 10301 ;
12092 ; 12802 ; 15425 ; 15564 ; **ISO** 1652 ; 2555 ;
2884-2 ; 3219 ; 10364-12

Languages

French/English/Russian/Spanish/Turkish/German

Supply voltage

90-240 VAC 50/60 Hz

Analog output

4 – 20 mA

PC connections

RS232 Port and USB

Printer connection

USB Host Port -
Compatible PCL/5

Dimensions and weight

Head : Ø 90 mm

Box D60 x H260 x W120

Weight: 2 kg

COMPATIBLES

MEASURING SYSTEMS

MS-RV (p75), **MS-LV** (p75), **MS-BV** (p76),
MS-VANES (p77), **MS-KREBS** (p77), **MS-SV** (p79),
MS-ULV (p78), **MS-DIN** (p72), **MS-R** (p74).

COMPATIBLES

TEMPERATURE CONTROLS

EVA LR (p60), **EVA MS DIN** (p58),
RT-1 PLUS (p61), **EVA MS-R** (p59).

OPTIONS & ACCESSORIES



- Standard or rack stand (p68).
- HELIPRO stand (p66).
- Small volume package (p67).
- THERMOCELL package (p61).
- Bayonet spindle rack (p69).
- Barcode reader with stand and cable (p68).
- Touch screen protector (p68).
- Viscosity standards oil (p69).
- Dymo printer (p68).
- RheoTex software (p64-65)

RM100 i

For viscosity measurement on large volume

The RM100 i is perfectly suited for so-called immersion use, installing it over a tank or on a support for a measurement in a pot. Only the measuring head is above the product, the electronic box can be installed more than 15 meters in a control cabinet with its 4-20mA output.



FEATURES AND BENEFITS

- Industrial measure on large tanker.
- Continuous measurement or with time to stop.
- 4-20 mA output for external control.
- 17m maximum distance between head and box.
- Usable with standard or rack stand.
- Huge viscosity range.
- Programming and recording methods.
- External temperature probe (option).
- Printer connection.
- Compatible with RheoTex software.
- Display of viscosity limits according to mobile and speed.

WHAT'S INCLUDED WITH DEVICE ?

(according to part number)

- 2m cable between measuring head and box.
- 1 Touch screen stylus.
- 1 User manual.
- 1 Calibration and checking certificate.
- 1 Microfiber cloth.

AVAILABLE INSTRUMENTS

Reference	Designation
T220200	RM100 i IMMERSION INDUSTRIAL VISCOMETER
T220230	RM100 i IMMERSION INDUSTRIAL VISCOMETER AC115
T220250	RM100 i IMMERSION INDUSTRIAL VISCOMETER WITH PT100 SENSOR

RM100 i

SPECIFICATIONS

Type of instrument

Rotating springless viscometer with 7" Touch screen

Rotation speeds

Unlimited number of speeds between 0.3 and 1500 rpm

Torque range

From 0.05 to 30 mNm

Accuracy

+/- 1 % of the full scale

Repeatability

+/- 0,2 %

Display

Viscosity (cP/Poises or mPa.s / Pa.s)

Speed – Shear rate – Torque – %- Shear stress - Time
– Temperature

Application

The RM100 i is dedicated to tank measurements for continuous monitoring of viscosity in production. Its 4-20mA analogue output is used to send the measured value to a central computer.

Numerous tailor-made solutions according to the customer configuration for integration into the process (length and height of the plungers, fixing on the cover of the measuring head with sealing,...).

Languages

French/English/Russian/Spanish/Turkish/German

Supply voltage

90-240 VAC 50/60 Hz

Analog output

4 – 20 mA

PC connections

RS232 Port and USB

Printer connection

USB Host Port -
Compatible PCL/5

Dimensions and weight

Head : Ø 95 mm

Box D140 x H260 x W120

Weight: 3 kg

COMPATIBLES
MEASURING SYSTEMS

MS-RV (p75), **MS-LV** (p75), **MS-BV** (p76),
MS-VANES (p77), **MS-KREBS** (p77), **MS-SV** (p79),
MS-ULV (p78), **MS-DIN** (p72), **MS-R** (p74).

COMPATIBLES
TEMPERATURE CONTROLS

EVA LR (p60), **EVA MS DIN** (p58),
RT-1 PLUS (p61), **EVA MS-R** (p59).

OPTIONS & ACCESSORIES



- External temperature probe -50°C to +300°C.
- Standard or rack stand (p68).
- HELIPRO stand (p66).
- Small volume package (p67).
- THERMOCELL package (p61).
- Barcode reader with stand and cable (p68).
- Touch screen protector (p68).
- Viscosity standards oil (p69).
- RheoTex software (p64-65).
- Cable extension 5 m (Ref. 113202) max 3 unit.

RM 100 L

The viscometer in line
with your process

The online viscosity measurement of the RM100 L guarantees continuous control for immediate action in production. Whatever the flow rate, the viscosity or the diameter of your pipe, this viscometer will be able to adapt by guaranteeing you a measurement according to laboratory's norms.

FEATURES AND BENEFITS

- Industrial on-line measurement.
- Continuous measurement or with time to stop.
- 4-20 mA output for external control.
- Magnetic bearing for sealing.
- 25m maximum distance between head and box.
- Huge viscosity range.
- Programming and recording methods.
- External temperature probe (option).
- Printer connection.
- Compatible with RheoTex software.
- Display of viscosity limits according to mobile and speed.

WHAT'S INCLUDED WITH DEVICE ?

(according to part number)

- 15m cable between measuring head and box.
- 1 Touch screen stylus.
- 1 User manual.
- 1 Calibration and checking certificate.
- 1 Microfiber cloth.



OPTIONS & ACCESSORIES



- Touch screen protector (p68).
- Viscosity standards oil (p69).
- RheoTex software (p64-65).
- Cable extension 5 m (Ref. 113202) max 2 units.
- Measuring cylinder and cell (see table next page).

RM100 L

SPECIFICATIONS

Type of instrument

Rotating springless viscometer with 7" Touch screen

Rotation speeds

Unlimited number of speeds between 0.3 and 1500 rpm

Torque range

From 0.05 to 30 mNm

Accuracy

+/- 1 % of the full scale

Repeatability

+/- 0,2 %

Display

Viscosity (cP/Poises or mPa.s / Pa.s)

Speed – Shear rate – Torque – %- Shear stress - Time
– Temperature**Norms**DIN : 3219 ; 52007-1 ; 53019-1 ; 54453 ; EN 3219 ;
ISO 1652; 3219**Application**

The RM100 L is dedicated to on-line measurements for continuous monitoring of viscosity in production. Its 4-20mA analogue output is used to send the measured value to a central computer.

Numerous tailor-made solutions according to customer configuration for process integration.

Languages

French/English/Russian/Spanish/Turkish/German

Supply voltage

90-240 VAC 50/60 Hz

Analog output

4 – 20 mA

PC connections

RS232 Port and USB

Printer connectionUSB Host Port -
Compatible PCL/5**Dimensions and weight**

Head : Ø 100 mm

Box D140 x H260 x W120

Weight: 4 kg

AVAILABLE INSTRUMENTS

Viscometer delivered with electronic box and measuring chamber. Need to be ordered with cylinder and cell.

Designation viscometer	Reference Viscometer	Compatible cylinder	Reference Cylinder	Compatible cell*	Reference (Cell)	SMS flange (mm)	Flow rate (m3/h)	Viscosity range (mPa.s)					
RM 100 L Short	T220330	MS DIN 20-15	121065	CD25	121038	25	0.03 to 0.12	1k to 0.67M					
				CD38	121057	38	0.05 to 0.5						
				CD50	121035	51	0.1 to 1						
				CD75	121034	76	0.5 to 2						
				LD75	121033	76	6 to 8						
				LD100	121032	104	10 to 14						
RM 100 L Standard	T220300 T220350 (with Fibox)	MS DIN 24	121036	CD25	121038	25	0.03 to 0.12	230 to 0.3M					
				CD38	121057	38	0.05 to 0.5						
				CD50	121035	51	0.1 to 1						
				CD75	121034	76	0.5 to 2						
				LD75	121033	76	6 to 8						
				LD100	121032	104	10 to 14						
		MS DIN 30	121026	CD25	121038	25	0.03 to 0.12	56 to 81K					
				CD38	121057	38	0.05 to 0.5						
				CD50	121035	51	0.1 to 1						
				CD75	121034	76	0.5 to 2						
				LD75	121033	76	6 to 8						
				LD100	121032	104	10 to 14						
				RM 100 L Long	T220320	MS DIN 31.5	121060		LD100	121032	104	10 to 14	5 to 29K
									CD75	121034	76	0.5 to 2	

M for millions, K for thousand / * CD for bended cell and LD for straight cell.



RHEOMETERS

- 40 RM 200 PLUS
- 42 RM 200 CP 4000 PLUS
- 44 DSR 500
- 46 DSR 500 CP 4000 PLUS

RM 200 PLUS

The rheology
at your fingertips



Thanks to its large storage capacity and its easy programming, the rheometer RM200 PLUS allows you to realize all your measurements of flow curves, yield point, thixotropic, analysis without software.

FEATURES AND BENEFITS

- Ramp programming.
- Direct analysis with regressions.
- Direct control of temperature unit.
- Huge viscosity range.
- Speed or shear rate control.
- Programming and recording method.
- Direct measure with time to stop.
- User and locked mode.
- Data recording and USB transfer.
- Torque gage on display.
- Integrated temperature probe.
- Printer connection.
- Compatible with RheoTex software.
- Display of viscosity limits according to mobile and speed.

WHAT'S INCLUDED WITH DEVICE ?

(according to part number)

- MS-R measuring system (p74).
- 1 Integrated temperature probe.
- 1 Standard stand or rack stand (p68).
- 1 Touch screen stylus.
- 1 User manual.
- 1 Calibration and checking certificate.
- 1 Microfiber cloth.

AVAILABLE INSTRUMENTS

Reference	Designation	Viscosity range (mPa.s)
N200000	RM 200 PLUS RHEOMETER (with standard stand)	1 to 780M*
N200009	RM 200 PLUS RHEOMETER (with rack stand)	1 to 780M*
N200110	RM 200 PLUS RHEOMETER with MS-R2-3-4 (with standard stand)	12 to 120M
N201000	RM 200 PLUS RHEOMETER with MS-R1 to MS-R5 (with standard stand)	12 to 475M

M for million / * According to measuring system (p72-79). Not included.

RM 200 PLUS

SPECIFICATIONS

Type of instrument

Rotating springless rheometer with 7" Touch screen

Rotation speeds

Unlimited number of speeds between 0.1 and 1500 rpm

Torque range

From 0.05 to 30 mNm

Temperature Probe

Equipped with a PT100 sensor which indicates temperatures between -50°C to +300°C

Accuracy

+/- 1 % of the full scale

Repeatability

+/- 0,2 %

Display

Viscosity (cP/Poises or mPa.s / Pa.s)
Speed – Shear rate – Torque – %- Shear stress - Time – Temperature

Norms

ASTM : D115 ; D789 ; D1076 ; D1084 ; D1337 ; D1338 ; D1417; D1439 ; D1824 ; D2196 ; D2243 ; D2364 ; D2556 ; D3288 ; D3468 ; D3716 ; D3730 ; D3794 ; D4016 ; D4143 ; D4878 ; D4889 ; D5324 ; D5400 ; D6279 ; D6577 ; D7394 ; D8020 ; E2975 ; F1607 ; BS 5350 ; DIN 2555 ; 3219 ; 52007-1 ; 53019-1; 54453 ; EN 302-7 ; 2555 ; 3219 ; 10301 ; 12092 ; 12802 ; 15425 ; 15564 ; IOCCC 2000 ; ISO 1652 ; 2555 ; 2884-2 ; 3219; 10364-12

Languages

French/English/Russian/Spanish/Turkish/German

Supply voltage

90-240 VAC 50/60 Hz

Analog output

4 – 20 mA

PC connections

RS232 Port and USB

Printer connection

USB Host Port -
Compatible PCL/5

What benefits are there for you?

Save your flow curves and calculate your rheological parameters directly without computer (Plastic viscosity, flow limit, regression model according to Newton, Bingham, Casson and Ostwald). Choose your attachment system tailored to your product constraints.

Dimensions and weight

Head: D180 x H230 x W130 mm
Aluminium stand: L280 x W200 x H30 mm
Stainless steel rod: Length 500 mm
Weight: 6.7 kg

COMPATIBLES MEASURING SYSTEMS

MS-RV (p75), MS-LV (p75), MS-BV (p76),
MS-VANES (p77), MS-KREBS (p77), MS-SV (p79),
MS-ULV (p78), MS-DIN (p72), MS-R (p74).

COMPATIBLES TEMPERATURE CONTROLS

EVA LR (p60), EVA MS DIN (p58),
RT-1 PLUS (p61), EVA MS-R (p59).

OPTIONS & ACCESSORIES +

- Carrying case (p68).
- External temperature probe -50°C to +300°C (p69).
- HELIPRO stand (p66).
- Small volume package (p67).
- THERMOCELL package (p61).
- Bayonet spindle rack (p69).
- Barcode reader with stand and cable (p68).
- Touch screen protector (p68).
- Dymo printer (p68).
- Viscosity standards oil (p69).
- RheoTex software (p64-65).

RM 200 CP 4000 PLUS

Optimize your
rheological
measurements

The motorized lift of the RM200 CP4000 PLUS allows a fast and repeatable installation of cone and plate measuring systems guaranteeing reliable rheological measurements whatever your application.



70 mm bottom plate

FEATURES AND BENEFITS

- Automatic lift for gap.
- Quick attachment with AC265 coupling.
- Ramp programming.
- Direct analysis with regressions.
- Direct control of temperature unit.
- Huge viscosity range.
- Speed or shear rate control.
- Programming and recording method.
- Direct measure with time to stop.
- User and locked mode.
- Data recording and USB transfer.
- Torque gage on display.
- Integrated temperature probe.
- Printer connection.
- Compatible with RheoTex software.
- Display of viscosity limits according to mobile and speed.

WHAT'S INCLUDED WITH DEVICE ?

(according to part number)

- 1 Temperature unit with 70mm bottom plate.
- 1 Touch screen stylus.
- 1 User manual.
- 1 Calibration and checking certificate.
- 1 Microfiber cloth.

OPTIONS & ACCESSORIES



- Barcode reader with stand and cable (p68).
- Touch screen protector (p68).
- Viscosity standards oil (p69).
- Dymo printer (p68).
- RheoTex software (p64-65).
- Protection cover (Ref. 121019).

RM 200 CP 4000 PLUS

SPECIFICATIONS

Type of instrument

Rotating springless rheometer with 7" Touch screen

Rotation speeds

Unlimited number of speeds between 0.1 and 1500 rpm

Torque range

From 0.05 to 30 mNm

Temperature Probe

Equipped with a PT100 sensor which indicates temperatures between -50°C to +300°C

Accuracy

+/- 1 % of the full scale

Repeatability

+/- 0,2 %

Display

Viscosity (cP/Poises or mPa.s / Pa.s)

Speed - Shear rate - Torque - %- Shear stress - Time - Temperature

Norms

ASTM : D4287 ;BS 3900 ;DIN 3219 ; 52007-1 ; 53019-1 ; 54453 ; ISO 2884; 3219 ; 10364-12

Languages

French/English/Russian/Spanish/Turkish/German

Supply voltage

90-240 VAC 50/60 Hz

Analog output

4 – 20 mA

PC connections

Port RS232 et USB

Printer connection

USB Host Port -
Compatible PCL/5

What benefits are there for you?

Save your flow curves and calculate your rheological parameters directly without computer (Plastic viscosity, flow limit, regression model according to Newton, Bingham, Casson and Ostwald). Choose your attachment system tailored to your product constraints.

Dimensions and weight

D610 x H700 x W340 mm

Weight: 22 kg

COMPATIBLES MEASURING SYSTEMS

MS-CP (p81).

AVAILABLE INSTRUMENTS

Reference	Designation	Viscosity range (mPa.s)
N240250	RM 200 CP4000 PLUS RHEOMETER AIR PELTIER (+10°C to +70°C)	1 to 636M (according to spindles MS CP (p81))
N240251	RM 200 CP4000 PLUS RHEOMETER AIR PELTIER (+10°C to +70°C) WITH PROGRAMMER*	
N240256	RM 200 CP4000 PLUS RHEOMETER + CYL*** AIR PELTIER (+10°C to +70°C)	
N240257	RM 200 CP4000 PLUS RHEOMETER + CYL*** AIR PELTIER (+10°C to +70°C) WITH PROGRAMMER*	
N240600	RM 200 CP4000 PLUS RHEOMETER AIR PELTIER (0°C to +150°C)	
N240601	RM 200 CP4000 PLUS RHEOMETER AIR PELTIER (0°C to +150°C) WITH PROGRAMMER*	
N240800	RM 200 CP4000 PLUS RHEOMETER LIQUID PELTIER** (-20°C to +100°C)	
N240801	RM 200 CP4000 PLUS RHEOMETER LIQUID PELTIER** (-20°C to +100°C) WITH PROGRAMMER*	
N240900	RM 200 CP4000 PLUS RHEOMETER (Room T°C to +300°C)	
N240901	RM 200 CP4000 PLUS RHEOMETER (Room T°C to +300°C) WITH PROGRAMMER*	

M for million / * Allow temperature setting by measuring head or RheoTex software. / ** Water circulating bath required. Not included. / *** Allow using of measuring systems as MS DIN (p72), MS VANE according to dimensions (p77) and MS SV (p79).

DSR 500

A new vision on your measurements



The rheometer with imposed shear rate equipped with a 7" touch screen to display the curves directly. And with direct report editing on a desktop printer, measuring viscosity or yield point has never been so easy!

FEATURES AND BENEFITS

- Direct curve on display.
- Shear rate and speed control.
- Ramp programming.
- Direct analysis with regressions.
- Direct control of temperature unit.
- Huge viscosity range.
- Programming and recording method.
- Direct measure with time to stop.
- User and locked mode.
- Data recording and USB transfer.
- Torque gage on display.
- Integrated temperature probe.
- Printer connection.
- Compatible with RheoTex software.
- Display of viscosity limits according to mobile and speed.

WHAT'S INCLUDED WITH DEVICE ?

(according to part number)

- 1 Stand for DSR500.
- 1 Touch screen stylus.
- 1 User manual.
- 1 Calibration and checking certificate.
- 1 Microfiber cloth.

AVAILABLE INSTRUMENT

Reference	Designation	Viscosity range (mPa.s)
N500100	DSR 500 RHEOMETER	1 to 780M*

M for million / * According to measuring system (p72-79). Not included.

DSR 500

SPECIFICATIONS

Type of instrument

Rotating springless rheometer with 7" Touch screen

Rotation speeds

Unlimited number of speeds between 0.1 and 1500 rpm

Torque range

From 0.05 to 30 mNm

Temperature Probe

Equipped with a PT100 sensor which indicates temperatures between -50°C to +300°C

Accuracy

+/- 1 % of the full scale

Repeatability

+/- 0,2 %

DisplayViscosity (cP/Poises or mPa.s / Pa.s)
Speed – Shear rate – Torque – %- Shear stress - Time – Temperature**Norms**ASTM : D115 ; D789 ; D1076 ; D1084 ; D1337 ; D1338 ;
D1417 ; D1439 ; D1824 ; D2196 ; D2243 ; D2364 ; D2556 ;
D3288 ; D3468 ; D3716 ; D3730 ; D3794 ; D4016 ; D4143
; D4878 ; D4889 ; D5324 ; D5400 ; D6279 ; D6577 ;
D7394 ; D8020 ; E2975 ; F1607 BS 5350 ;
DIN 2555 ; 3219 ; 52007-1 ; 53019-1; 54453 EN 302-7 ;
2555 ; 3219 ; 10301 ; 12092 ; 12802 ; 15425 ; 15564 ;
IOCCC 2000 ; ISO 1652 ; 2555 ; 2884-2 ; 3219;
10364-12**Languages**

French/English/Turkish/German

Supply voltage

90-240 VAC 50/60 Hz

Analog output

4 – 20 mA

PC connections

RS232 Port and USB

Printer connectionUSB Host Port -
Compatible PCL/5**What benefits are there for you?**

Memorize your flow ramps, draw your curves and calculate your rheological parameters directly without computer (plastic viscosity, flow limit and rheological models: Newton, Bingham, Casson, and Ostwald). Edit your measurement reports directly on printer.

Dimensions and weightHead: D160 x H270 x W200 mm
Aluminium stand: L280 x W200 x H30 mm
Stainless steel rod: Length 500 mm
Weight: 6.7 kg

COMPATIBLES

MEASURING SYSTEMS

MS-RV (p75), MS-LV (p75), MS-BV (p76),
MS-VANES (p77), MS-KREBS (p77), MS-SV (p79),
MS-ULV (p78), MS-DIN (p72), MS-R (p74).

COMPATIBLES

TEMPERATURE CONTROLS

EVA LR (p60), EVA MS DIN (p58),
RT-1 PLUS (p61), EVA MS-R (p59).

OPTIONS & ACCESSORIES



- Carrying case (p68).
- HELIPRO stand (p66).
- Small volume package (p67).
- THERMOCELL package (p61).
- Barcode reader with stand and cable (p68).
- Bayonet spindle rack (p69).
- Touch screen protector (p68).
- Viscosity standards oil (p69).
- Dymo printer (p68).
- RheoTex software (p64-65).
- External temperature probe -50°C to +300°C (p69).

DSR 500 CP 4000 PLUS

A rheometer
to meet
your requirements



With its motorized lift and built-in temperature control unit, this new cone-plate rheometer optimizes your measurements.

FEATURES AND BENEFITS

- Automatic lift for gap.
- Quick attachment with AC265 coupling.
- Direct curve on display.
- Shear rate and speed control.
- Ramp programming.
- Direct analysis with regressions.
- Direct control of temperature unit.
- Huge viscosity range
- Programming and recording method.
- Direct measure with time to stop.
- User and locked mode.
- Data recording and USB transfer.
- Torque gage on display.
- Integrated temperature probe.
- Printer connection.
- Compatible with RheoTex software.
- Display of viscosity limits according to mobile and speed.

WHAT'S INCLUDED WITH DEVICE ?

(according to part number)

- 1 Temperature unit with 70mm bottom plate.
- 1 Touch screen stylus.
- 1 User manual.
- 1 Calibration and checking certificate.
- 1 Microfiber cloth.

AVAILABLE INSTRUMENTS

Reference	Designation	Viscosity range (mPa.s)
N500400	DSR 500 CP4000 PLUS RHEOMETER AIR PELTIER (+10°C to +70°C)	1 to 636M (according to spindles MS CP (p81))
N500401	DSR 500 CP4000 PLUS RHEOMETER AIR PELTIER (+10°C to +70°C) WITH PROGRAMMER*	
N500410	DSR 500 CP4000 PLUS RHEOMETER AIR PELTIER (0°C to +150°C)	
N500411	DSR 500 CP4000 PLUS RHEOMETER AIR PELTIER (0°C to +150°C) WITH PROGRAMMER*	
N500420	DSR 500 CP4000 PLUS RHEOMETER LIQUID PELTIER** (-20°C to +100°C)	
N500421	DSR 500 CP4000 PLUS RHEOMETER LIQUID PELTIER** (-20°C to +100°C) WITH PROGRAMMER*	
N500430	DSR 500 CP4000 PLUS RHEOMETER (Room T°C to +300°C)	
N500431	DSR 500 CP4000 PLUS RHEOMETER (Room T°C to +300°C) WITH PROGRAMMER*	
N500426	DSR 500 CP4000 PLUS RHEOMETER + CYL*** AIR PELTIER (+10°C to +70°C) WITH PROGRAMMER*	
N500427	DSR 500 CP4000 PLUS RHEOMETER + CYL*** AIR PELTIER (+10°C to +70°C)	

M for million / * Allow temperature setting by measuring head or RheoTex software. / ** Need a circulating water bath. Not included. / *** Allow using of measuring system MS DIN (p72), MS VANE (according to dimensions p77) and MS SV (p79).

DSR 500 CP 4000 PLUS

SPECIFICATIONS

Type of instrument

Rotating springless rheometer with 7" Touch screen

Rotation speeds

Unlimited number of speeds between 0.1 and 1500 rpm

Torque range

From 0.05 to 30 mNm

Temperature Probe

Equipped with a PT100 sensor which indicates temperatures between -50°C to +300°C

Accuracy

+/- 1 % of the full scale

Repeatability

+/- 0,2 %

Display

Viscosity (cP/Poises or mPa.s / Pa.s)

Speed - Shear rate - Torque - % - Shear stress - Time - Temperature

Norms

ASTM : D4287 ; BS 3900 ; DIN 3219 ; 52007-1 ; 53019-1 ; 54453 ; ISO 2884; 3219 ; 10364-12

Languages

French/English/Turkish/German

Supply voltage

90-240 VAC 50/60 Hz

Analog output

4 - 20 mA

PC connections

RS232 Port and USB

Printer connection

USB Host Port -
Compatible PCL/5

What benefits are there for you?

Memorize your flow ramps, draw your curves and calculate your rheological parameters directly without computer (plastic viscosity, flow limit and rheological models: Newton, Bingham, Casson, and Ostwald). Edit your measurement reports directly on printer.

Dimensions and weight

D610 x H700 x W340 mm

Weight: 22 kg

COMPATIBLES MEASURING SYSTEMS

MS-CP (p81).

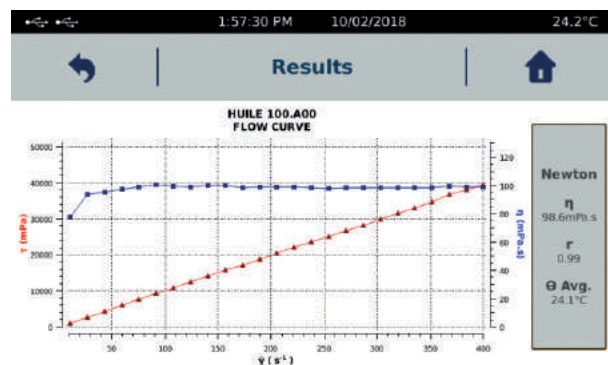

OPTIONS & ACCESSORIES



- Barcode reader with stand and cable (p68).
- Touch screen protector (p68).
- Viscosity standards oil (p69).
- Dymo printer (p68).
- RheoTex software (p64-65).
- Protection cover (Ref.121019).



TEXTURE ANALYZER

- 50 TX-700
- 52 PROBES
- 53 FIXTURES

TX-700

The tactile texture analyzer



With its wide range of probes and fixtures, the TX 700 is the ideal tool for your texture analysis. Thanks to its touch screen directly displaying the curves, its method programming capability, storage and analysis of measurements, the TX 700 will fit in laboratory and production area.

FEATURES AND BENEFITS

- Integrated temperature probe.
- Direct curve on display.
- Programming and recording methods.
- Data recording and USB transfer.
- Many different probes and fixtures.
- Interchangeable force sensors.
- Height adjustable tray.
- Compatible with RheoTex software.

WHAT'S INCLUDED WITH DEVICE ?

(according to part number)

- 1 Interchangeable force sensor.
- 1 Temperature probe PT100 (-50°C à 300°C).
- 1 Height adjustable tray.
- 1 Touch screen stylus.
- 1 User manual.
- 1 Calibration and checking certificate.
- 1 Microfiber cloth.

AVAILABLE INSTRUMENTS

Reference	Designation
N151010	TX-700 TEXTURE ANALYZER - 10 N
N151020	TX-700 TEXTURE ANALYZER - 20 N
N151050	TX-700 TEXTURE ANALYZER - 50N
N151250	TX-700 TEXTURE ANALYZER - 250 N
N151500	TX-700 TEXTURE ANALYZER - 500 N

TX-700

SPECIFICATIONS

Type of device

Texture Analyzer operating in Compression and Traction with 7" Touch screen

Choice of sensors

10 N (1 kg), Resolution 0.001 N (0.1 g)
 20 N (2 kg), Resolution 0.001 N (0.1 g)
 50 N (5 kg), Resolution 0.001 N (0.1 g)
 250 N (20 kg), Resolution 0.01 N (1 g)
 500 N (50 kg), Resolution 0.01 N (1 g)

Accuracy

+/- 0.1 % of the full scale

Speed range

From 0.1 to 10 mm/s +/-0.2 %

Motion

Height: 330 mm / Resolution: 0.1 mm

Temperature Probe

Equipped with a PT100 sensor which indicates temperatures between -50°C to +300°C

Display

Force – Speed – Distance – Temperature - Time –
 Measuring probe – Level of sensitivity
 Date/hour - Choice of force units: gram or Newton

Languages

French/English/Turkish/German

Security and confidentiality

An «operator» function allows you to enter a username for your instrument. This user must then be identified using a 4-digit code. There is also a protected mode that locks your measurement conditions.

Supply voltage

90-240 VAC 50/60 Hz

PC connections

RS232 Port

Printer connection

USB Host Port -
 Compatible PCL/5

What benefits are there for you?

Integrated adjustable turntable: diam. 160 mm. Table for attaching inserts: 120 x 220 mm.
 Available Operating Modes: Compression – Relaxation – Traction – TPA Cycle – Penetrometry and relative compression mode also. Large selection of probes available and custom probes can be made with choice of material, shape and size according to your criteria. The TX700 has a large 7" colour touch screen which allows comfortable use and optimal viewing of measurements. Storage of your measuring methods. Data can be backed up and exported using a USB stick. External control thanks to the optional software.

Dimensions and weight

D610 x W340 x H710 mm
 Weight: 25 kg









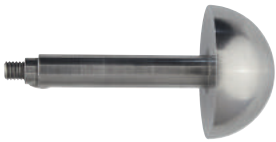

CALIBRATION KIT

OPTIONS & ACCESSORIES



- Probes (p52).
- Fixtures (p53-55).
- Barcode reader with stand and cable (p68).
- Touch screen protector (p68).
- Calibration Kit: 10-20N (Ref.150060) ; 50-250N (Ref.150070) ; 500N (Ref.150080).
- RheoTex software (p64-65).
- Force sensor: 10N (Ref : N150010) ; 20N (Ref : N150020) ; 50N (Ref : N150050) ; 250N (Ref : N150250) ; 500N (Ref : N150500).

PROBES

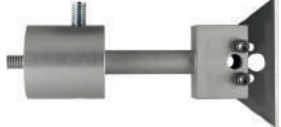
Name / Material	Ref.	∅ (mm)	Height (mm)	Interest for	
1/2 SPHERICAL PROBE 316L Stainless Steel	130079 130174 130019 130049	8 16 30 40	-	Consistency, elasticity, adhesion and spinning on gel and cream.	
FLAT PROBE 316L Stainless Steel	130080 130083 130101 130175 130200 130177	34 40 50 75 100 160	-	Consistency, elasticity, adhesion and spinning on a solid of size smaller than the plateau.	
BLOOM PROBE plexiglass	130046	12.7	30	Bloom Gel Strength test	
CYLINDRICAL PROBE 316L Stainless Steel	130077 130063 130078 130066 130124 130099 130037 130176 130126	2 3 4 6 10 20 25 36 50	35 35 35 35 40 40 40 40 50	Measure in texture penetration on solid sample	
CONICAL PROBE 316L Stainless Steel	130020 130047 121023	25 30 30	20° Cône 45° Cône 30° Cône	Measurement in consistency penetration on solid sample (spreading)	
NEEDLE	130179	3	60	Core consistency	
CLEAVER PROBE 316L Stainless Steel	130064	L. 25 mm	60° Angle	Breaking Force, Knack	
SPHERICAL PROBE 316L Stainless Steel	130191 130134 130149	12,7 19,5 20	-	Consistency, elasticity and adhesion on soft to strong sample	
MESH PROBE	130158	50mm (adjustable)	-	Consistency of product with big particle as yogurt, sauce, jam.	
KNIFE PROBE	120012	-	-	Cutting force.	

More size and material on request (Aluminium, PEEK, DELRIN, PMMA)

FIXTURES

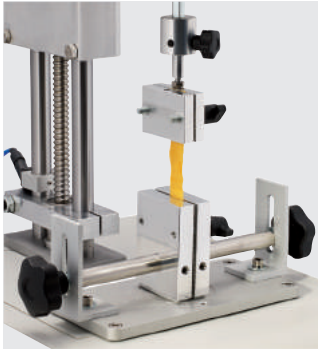

**TENSILE
FIXTURE**
(Ref. 130092)

Tensile force.

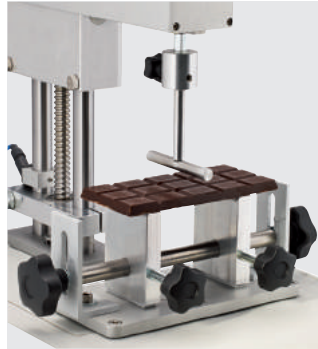

**3 POINTS BEND
FIXTURE**
(Ref. 130091)

Breaking force, Friability,
Springiness.



**KRAMER 5 BLADES
FIXTURE**
(Ref. 130094)

Hardness and tenderness
on small samples
(Requires table Ref. 310106).

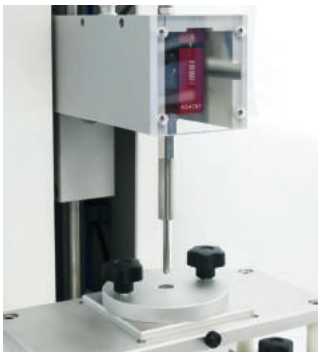

**FILM COMPRESSION
FIXTURE**
(Ref. 130031)

Accessory to measure
strenght of film
(Requires table Ref. 310106).



**LIPSTICK CANTILEVER
FIXTURE**
(Ref. 130147)

Accessory to measure
strenght of lipstick.

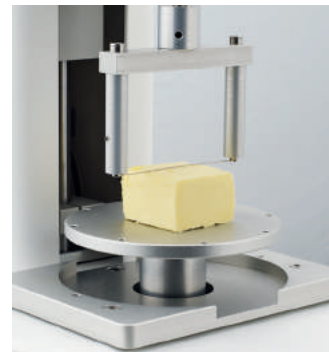

**WIRE SHEAR
FIXTURE**
(Ref. 130076)

Accessory to measure
consistency of product
as Butter or Cheese.



**SYRINGE
TEST FIXTURE**
(Ref. 130145)

Study of needed force
to use syringe.

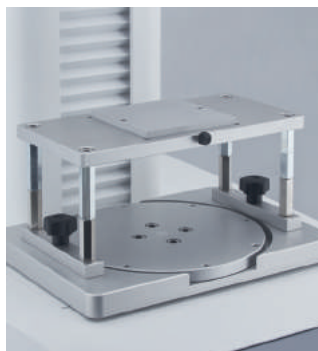

**FIXTURE BASE
TABLE**
(Ref. 310106)

Universal holder
for fixture and sample.



EXTRUSION FIXTURE
(Ref. 100200)

Foward and backward extrusion of
liquid, cream, paste, gel
(Requires table Ref. 310106).

FIXTURES



**MINI OTTAWA
FIXTURE**
(Ref. 130097)

Hardness and tenderness on small samples.
(Requires table Ref. 310106).



**PASTA
FIXTURE**
(Ref. 130152)

Firmness and stickiness of pasta.
(Requires table Ref. 310106).



**VOLODKEVICH
FIXTURE**
(Ref. 130068)

Shear cut and bite test.
(Requires table Ref. 310106).



**MOHRS
PROBE**
(Ref. 130165)

Cutting test with blade for meat, fish...



**FRICTION
FIXTURE**
(Ref. 120013)

Friction measurement according to ASTM D1894.



**DOUGH STICKINESS
FIXTURE**
(Ref. 121017)

Measure of dough stickiness.
(Requires table Ref. 310106).



**NOODLE TENSILE
FIXTURE**
(Ref. 130168)

Measure of noodle elasticity and rupture.



**SPREAD TEST
FIXTURE**
(Ref. 130157)

Measure of the spreading capacity of creams, pastes and gels.
(Requires table Ref. 310106).



**WARNER-BRATZLER
FIXTURE**
(Ref. 130074)

Cutting blade fine.

FIXTURES



THREE RINGS PROBE CUTTING
(Ref. 130186)

Measure firmness of sample as pasta, rice, corn...



KIEFFER DOUGH EXTENSIBILITY FIXTURE
(Ref. 130148)

Measure of dough elasticity and rupture.
(Requires table Ref. 310106).



COMPRESSION TOP PLATE FIXTURE
(Ref. 130153)

Measure firmness by uniform compression.
(Requires table Ref. 310106).



MULTIPLE PROBE FIXTURE
(Ref. 130170)

Probe for puncture on 9 sample.



8 PROBES KIT
(Ref. 130166)

Reference	Designation
121023	CONICAL PROBE 30°
130019	1/2 SPHERICAL PROBE DIAMETER 30 mm
130037	CYLINDRICAL PROBE H:25 mm Diam:40 mm
130064	CLEAVER PROBE 25 mm
130077	CYLINDRICAL PROBE DIAMETER 2 mm
130079	1/2 SPHERICAL PROBE DIAMETER 8 mm
130101	FLAT PROBE DIAMETER 50 mm
130124	CYLINDRICAL PROBE DIAMETER 10 mm

WE CAN ALSO MAKE CUSTOMISED PROBES AND FIXTURES ON REQUEST.



TEMPERATURE CONTROLS

- 58 EVA MS-DIN PLUS & MS-DIN/MS-R
- 59 EVA MS-R PLUS
- 60 EVA LR PLUS
- 61 RT-1 PLUS + THERMOCELL PACKAGE

EVA MS-DIN PLUS & MS-DIN / MS-R

FEATURES AND BENEFITS

- Temperature range -20°C to +150°C (according to model).
- Fast temperature regulation by Peltier element.
- Compatible with coaxial cylinders.
- Compatible with MS-R measuring system (according to model).



Chamber of
EVA MS DIN/MS-R PLUS

AVAILABLE TEMPERATURE DEVICES

Compatible only with bayonet coupling device

Designation	Ref.	Temperature range	Type	Bath*	Prog***	Compatible instrument	Compatible measuring system	Dimensions (p×l×h) in mm	Weight
EVA MS DIN PLUS	N950000	+5°C to +65°C	Peltier	No	No	B-ONE FIRST RM100** RM200 DSR 500	MS DIN, MS SV, MS ULLV, MS-Chocolat	610x340x650	15Kg
EVA MS DIN PLUS	N950005	+5°C to +65°C	Peltier	No	Yes				
EVA MS DIN PLUS	N950003	-20°C to +100°C	Peltier	Yes	No				
EVA MS DIN PLUS	N950012	-20°C to +100°C	Peltier	Yes	Yes				
EVA MS DIN PLUS	N950008	0°C to +150°C	Peltier	No	No				
EVA MS DIN PLUS	N950009	0°C to +150°C	Peltier	No	Yes				
EVA 100 PLUS	N950100	Room T°C to +100°C	Electrical	No	No				
EVA MS DIN/MS-R PLUS	N950002	+5°C to +65°C	Peltier	No	No	RM100** RM200 DSR 500	MS DIN, MS SV, MS ULLV, MS-Chocolat, MS-R	610x340x650	15Kg
EVA MS DIN/MS-R PLUS	N950004	+5°C to +65°C	Peltier	No	Yes				
EVA MS DIN/MS-R PLUS	N950013	-20°C to +100°C	Peltier	Yes	No				
EVA MS DIN/MS-R PLUS	N950020	-20°C to +100°C	Peltier	Yes	Yes				
EVA MS DIN/MS-R PLUS	N950030	0°C to +150°C	Peltier	No	No				
EVA MS DIN/MS-R PLUS	N950040	0°C to +150°C	Peltier	No	Yes				

* Circulating bath not included. Required for counter cooling of Peltier. / ** Compatible with Portable RM100 and RM100 i. / *** Allow temperature setting by measuring head or RheoTex software.

EVA MS-R PLUS

FEATURES AND BENEFITS

- Temperature range +12°C to +60°C.
- Can accommodate two instruments.
- Support for 9 simultaneous samples.



AVAILABLE TEMPERATURE DEVICES

Compatible only with bayonet coupling device (not compatible with B-ONE / FIRST).

Designation	Ref.	Temperature range	Type	Compatible instrument	Compatible measuring system	Dimensions (pxlxh) in mm	Weight
EVA MS-R PLUS 9 Holes	N950200	+17°C to +45°C	Peltier	RM 100* RM 200 DSR 500	MS-R	610x340x650	15kg
EVA MS-R PLUS 9 Holes	N950210	+12°C to +60°C	Peltier				

* Compatible with Portable RM100 and RM100 i.

EVA LR PLUS

FEATURES AND BENEFITS

- Temperature range +15°C to +45°C (according to model).
- Compatible with bayonet coupling device.
- Rapid temperature setting of 600 ml beakers according to ISO 2555.



600 ml BEAKER

AVAILABLE TEMPERATURE DEVICE

Compatible only with bayonet coupling device

Designation	Reference	Temperature range	Type	Compatible measuring system	Dimensions (pxlxh) in mm	Weight
EVA LR PLUS*	N950006	+15°C to +45°C	Peltier	MS RV-LV	610x340x650	15kg

* Usable with 600ml beaker.

RT-1 PLUS + THERMOCELL PACKAGE



FEATURES AND BENEFITS

- Temperature range from Room T°C to +300°C.
- Economic electric oven.
- Compatible with bayonet coupling device.

WHAT'S INCLUDED WITH THERMOCELL PACKAGE ?

(Ref. N130150)

- 1 RT-1 PLUS oven (Ref. N130130).
- 1 Choice of one MK-SV spindle (p 76).
- 1 Cup MB-SV13R (Ref. 116213).
- 1 Holder H-SV13RD (Ref. 116313) for disposable cup MB-SV13RD.
- 5 Disposable cups MB-SV13RD (Ref. 116413 for 100pcs).
- 1 Centring tool ST-R (Ref. 114436).



AVAILABLE TEMPERATURE DEVICES

Compatible with bayonet coupling device

Designation	Reference	Temperature range	Type	Compatible measuring system	Dimensions (pxlxh) in mm	Weight
RT1 PLUS + PROGRAMMER	N130130*	Room T°C to +300°C	Electrical	MS SV, MS DIN, MS ULV.	610x340x650	15kg
RT1 PLUS	N130110	Room T°C to +300°C	Electrical			

* Allow temperature setting by measuring head or RheoTex software.

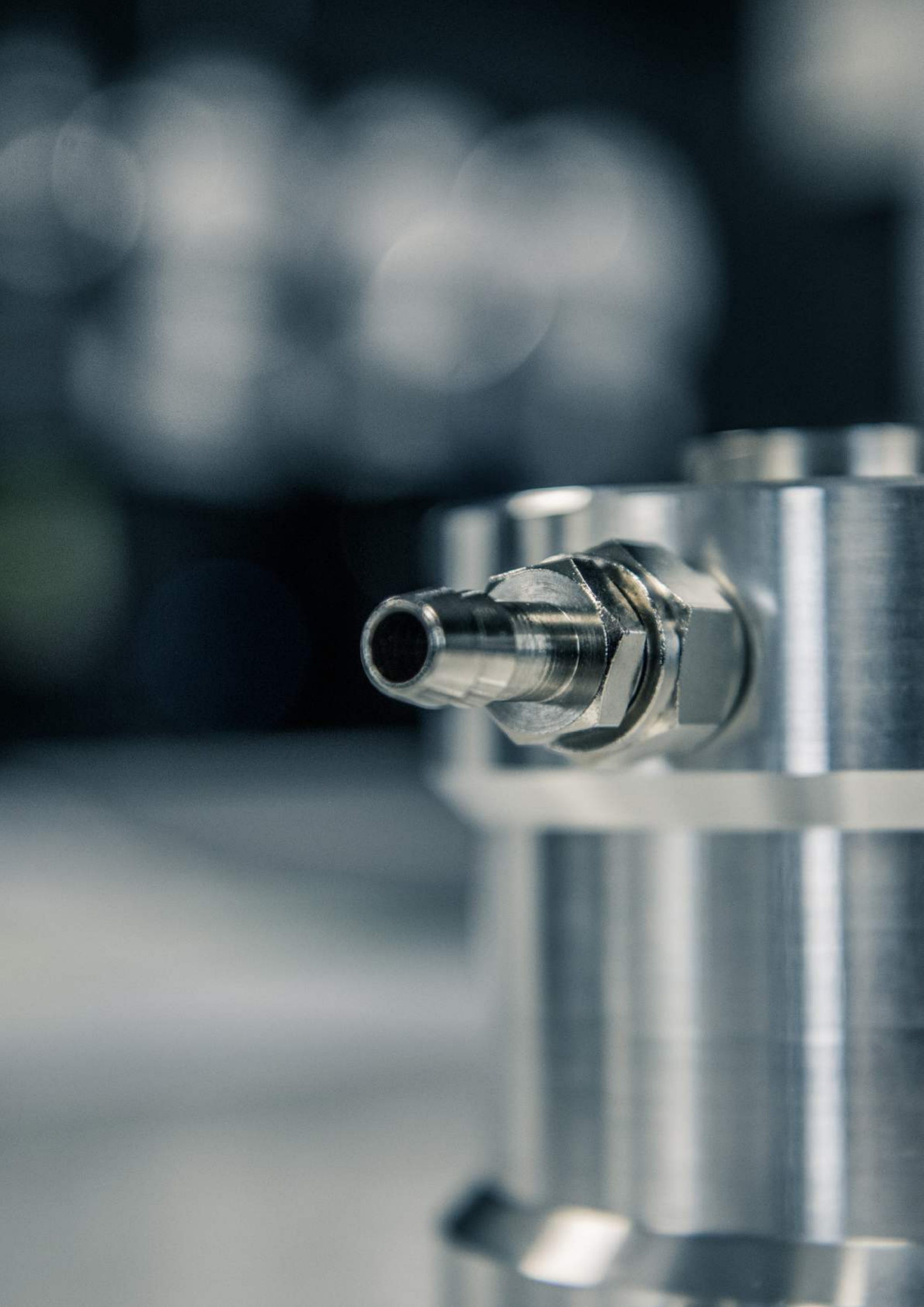

ACCESSORIES

- 64 RHEOTEX SOFTWARE
- 66 HELIPRO STAND
- 67 WATER JACKET + SMALL VOLUME PACKAGE
- 68 ACCESSORIES

SOFTWARE

RHEOTEX

The new RheoTex software developed by LAMY RHEOLOGY allows control of all instruments (excepted : B-ONE PLUS)

The license file associated with the software allows you to automatically configure software to be compatible with instrument. Since the software base is the same, only an additional license is required when you have two devices to control by RheoTex. The installation of the software is not limited to one computer station.

The integrity of results and methods is guaranteed by using a database and by an optimized management of the users with specific rights.

New graphical tools allow custom management of the display of curves, tables and analysis results.

FEATURES AND BENEFITS

- Creation and saving of methods.
- Transfer data from device memory.
- Temperature ramp method.
- Use of mathematical tools for data analysis.
- Creation of free program.
- PDF report editing.
- Compatible with office software or experience creation (automatic measurement and analysis).
- 21 CFR Part 11 Compatible (from 06/2021).

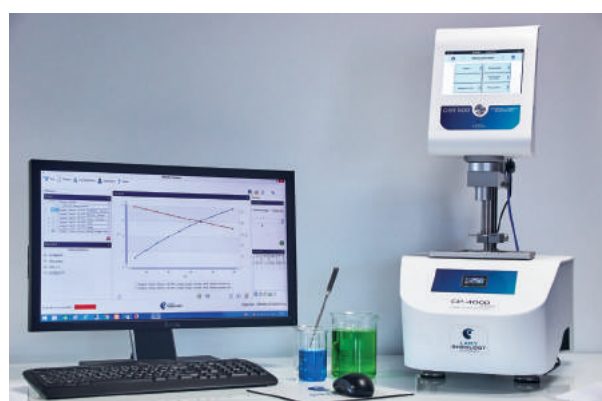

SOFTWARE

AVAILABLE CONFIGURATIONS

RheoTex for
FIRST PLUS/FIRST PRO
Ref. N311000 +
license **Ref. N311700**

RheoTex for
RM200 PLUS
Ref. N311000 +
license **Ref. N311200**

RheoTex for
TX-700
Ref. N311000 +
license **Ref. N311777**

RheoTex for
GT300 PLUS
Ref. N311000 +
license **Ref. N311300**

RheoTex for
DSR 500 CP 4000 PLUS
Ref. N311000 +
license **Ref. N311504**

RheoTex for
GT300 PRODIG
Ref. N311000 +
license **Ref. N311310**

RheoTex for
DSR 500
Ref. N311000 +
license **Ref. N311500**

RheoTex for
RM100 CP 2000 PLUS
Ref. 311000 +
license **Ref. N311202**

RheoTex for
FIRST PRODIG,
FIRST PRODIG CP 1000
Ref. N311000 + license **Ref. N311710**

RheoTex for
RM100 PLUS, RM100 PORTABLE,
RM100i, RM100L, RM 100 CP 1000
Ref. N311000 + license **Ref. N311100**

RheoTex for
RM200 CP 4000 PLUS
Ref. N311000 +
license **Ref. N311204**

RHEOTEX FUNCTIONS ACCORDING TO INSTRUMENTS

Functions / Instrument version	FIRST	FIRST PRO	FIRST PRODIG	RM 100	RM 200	DSR 500	GT300	GT300 PRODIG	TX-700
Instrument connection	USB, RS232								RS232
Method viscosity over time	*	*	*	*	*	*	*	*	
Method step by step	*	*	*	*	*	*			
Method flow curve			*		*	*			
Methods Compression, Relaxation, Tensile, TPA, Penetrometry									*
Methods Free Program	*	*	*	*	*	*	*	*	*
Loop mode	*	*	*	*	*	*	*	*	*
Experiment	*	*	*	*	*	*	*	*	*
Logarithmic ramp			*		*	*			
Control of temperature unit (EVA, RT, CP1, CP2000, CP4000)*	*	*	*	*	*	*	*	*	
Data transfer from device memory	*	*	*	*	*	*	*	*	*
Direct curve while test	*	*	*	*	*	*	*	*	*
Import methods and results	*	*	*	*	*	*	*	*	*
Export/copy data to Office	*	*	*	*	*	*	*	*	*
Export/copy diagram to Office	*	*	*	*	*	*	*	*	*
Editing report pdf	*	*	*	*	*	*	*	*	*
Display multiple curves	*	*	*	*	*	*	*	*	*
Lift control					For CP4000				*
Role/user management	*	*	*	*	*	*	*	*	*
21 CFR Part 11 (from 06/2021)	*	*	*	*	*	*	*	*	*
Automatic stop on measured value	*	*	*	*	*	*	*	*	*
Mathematic analysis of results	Maximum, minimum, average, curves average, smoothing, interpolation, inflexion								
Analysis as Area, Slope, TPA, relaxation									*
Rheological models	Newton, Ostwald, Bingham, Casson, Casson-Steiner, Chocolat				Newton, Ostwald, Bingham, Casson, Power Law, Herschel-Bulkley, Casson-Steiner, Steiger Ory, Chocolat				

* Only for temperature unit with programmer.

HELIPRO



T-Bars spindles
and holder

MEASURING SYSTEMS

T-BARS SPINDLES WITH VISCOSITY RANGE* (mPa.s)

Designation T-Bars**	Reference	Instrument LR		B-ONE AND FIRST		RM100, RM200, DSR500	
		Minimum	Maximum	Minimum	Maximum	Minimum	Maximum
T-A (91)	180091	93	740K	930	12M	930	28M
T-B (92)	180092	186	1.5M	1,9K	25M	1,9K	56M
T-C (93)	180093	464	3.7M	4,6K	60M	4,6K	140M
T-D (94)	180094	1K	7.5M	9,2K	120M	9,2K	280M
T-E (95)	180095	1,9K	15M	18,6K	240M	18,6K	558M
T-F (96)	180096	4,6K	37M	46,4K	600M	46,4K	1400M

The HELIPRO device makes it possible to measure viscosity of gels, pastes, creams and more generally products that do not flowing.

When a measuring mobile turns in this type of product, we can observe appearance of cavities around the rotating spindle which has effect of reducing measured viscosity values. Through its movement vertical, HELIPRO system with its mobile T shape will prevent formation of cavities within product and will ensure reliable and consistent measurement.

This accessory is compatible with viscometers and rheometers from the LAMY RHEOLOGY range except FIRST PRODIG CP 1000, RM 100 CP 1000/2000 PLUS, RM 200 CP 4000 PLUS, GT-300 PLUS, GT-300 PRODIG and DSR 500 CP 4000 PLUS.

WHAT'S INCLUDED WITH HELIPRO STAND ? (Ref. 111015)

- 1 Stand with motorized lift.
- 1 Complete case (Ref. 950500) with 6 T-Bars (Ref. 180006) and holder (Ref. 200200).
- Tools for lift setting.

DIMENSIONS AND WEIGHT

D330 x W200 x H500mm

Weight 9Kg

WATER JACKET + SMALL VOLUME PACKAGE

SMALL VOLUME PACKAGE SVP180 (Ref. 600950)



CT-DIN (Ref. 111914), temperature range from -20°C to +180°C.

WATER JACKET

Our fluid circulation jacket allow use of all measurement systems including cylinder and cup by ensuring precise temperature control associated with a circulation bath (not supplied).

Sold separately or as package, these accessories are compatible with all viscometers and rheometers in the LAMY RHEOLOGY range excepted FIRST PRODIG CP 1000, RM 100 CP 1000/2000 PLUS, RM 200 CP 4000 PLUS, GT-300 PLUS, GT-300 PRODIG and DSR 500 CP 4000 PLUS.

SMALL VOLUME PACKAGE SVP65 OR SVP180

(Ref. 600900 or 600950)

- 1 Water jacket CT-DIN or CT-LC.
- 1 MK-SV spindle choice (p76).
- 1 MB-SV measuring cup choice (p76).
- 1 Centring tool ST-R (Ref. 114436).
- 2 Silicon pipe (1m).

COMPATIBLES MEASURING SYSTEMS

MS-DIN (p72), MS-R according to spindle (p74), MS-VANES according to spindle (p77), MS-ULV (p78), MS-SV (p79).

DIMENSIONS AND WEIGHT

CT-DIN (Ref. 111914)
Ø100 x H200 mm
Weight 3Kg

CT-LC (Ref. 600800)
D70 x W70 x H160 mm
Weight 1,5Kg

SMALL VOLUME PACKAGE SVP65 (Ref. 600900)



CT-LC (Ref. 600800), temperature range from -20°C to +65°C.

ACCESSORIES

BARCODE READER

(Ref. N330000)



This barcode reader allows you to quickly identify your sample without risk of data entry errors. It is compatible with all instruments in the LAMY RHEOLOGY range thanks to their USB port and with RHEOTEX software when connected to the computer. Included USB cable and holder.

DYMO LABEL PRINTER

(Ref. 500200) + paper roll (Ref. 500300)



This DYMO 450 printer can be connected to all compatible instruments (except B-ONE PLUS and B-ONE PORTABLE viscometer). It allows rapid printing at the end of measurement or at time intervals set by user while measurement. USB cable supplied and roll of paper.

STANDARD STAND

(Ref. 112950)



The standard stand allows you to install your LAMY RHEOLOGY viscometer or rheometer on table. Thanks to its stop ring, it is recommended when the height of the measurement position is constant. Included according to instrument model, it includes a rod, a stop ring, a safety sleeve, a arm and a base.

RACK STAND

(Ref. P008000)



The rack stand allows you to install your LAMY RHEOLOGY viscometer or rheometer on table. Thanks to its notched rod system, it allows easy vertical movement of measuring head and is recommended when height of measuring position varies according to container or measuring spindle used. Included according to instrument models, it includes a notched shank, arm and base.

TOUCH SCREEN PROTECTOR

(Ref. 000630)



The screen protector provides permanent protection for touch screen of instruments in the LAMY RHEOLOGY range. It is effective against projections and dust while ensuring ease of use.

CARRYING CASE

(Ref. 100048)

or without foam (Ref. 100500)



If you want to transport or store your instrument, we offer this robust transport case with protective foam suitable for your viscometer or rheometer. A space is dedicated for storage of accessories such as supports or measuring systems.

ACCESSORIES

VISCOSITY STANDARD OIL



Our viscosity standard oils allow you to verify the correct measurement made by your instrument. The choice of oil must be made according to viscosity range of products measured and required volume (e.g. 500ml for MS RV or MS LV mobiles or 100 ml for MS DIN or MS SV mobiles). They are delivered with a certificate established by LAMY RHEOLOGY. Other standard oils for high temperature measurements or supplied with NIST certificate are available on demand.

Reference	Volume and viscosity value at 23°C
260100	Standard Silicone Oil 100 mPas (100 ml)
261000	Standard Silicone Oil 1000 mPas (100 ml)
265500	Standard Silicone Oil 3500 mPa.s (100 ml)
260005	Standard Silicone Oil 5 mPas (100 ml)
260050	Standard Silicone Oil 50 mPas (100 ml)
260500	Standard Silicone Oil 500 mPas (100 ml)
265000	Standard Silicone Oil 5000 mPa.s (100 ml)
250100	Standard Silicone Oil 100 mPas (250ml)
251000	Standard Silicone Oil 1000 mPas (250ml)
250055	Standard Silicone Oil 5 mPas (250ml)
250050	Standard Silicone Oil 50 mPas (250ml)
250500	Standard Silicone Oile 500 mPas (250ml)
255000	Standard Silicone Oil 5000 mPa.s (250ml)
500100	Standard Silicone Oil 100 mPas (500ml)
501000	Standard Silicone Oil 1000 mPas (500ml)
500005	Standard Silicone Oil 5 mPas (500ml)
500050	Standard Silicone Oil 50 mPas (500ml)
500500	Standard Silicone Oil 500 mPas (500ml)
505000	Standard Silicone Oil 5000 mPa.s (500ml)

BAYONET SPINDLE RACK

(Ref. 000590)



This rack allows you to store in complete safety and near your instrument all the spindles having a bayonet coupling such as MS DIN, MS SV, MS-R, MS ULV, MS Krebs, MS Chocolat, MS VANE, MS RV and MS LR.

EXTERNAL TEMPERATURE PROBE WITH HOLDER

(Ref. 900026 and 405000)



This temperature probe can be connected to viscometers and rheometers of LAMY RHEOLOGY range and is particularly well suited for B-ONE PLUS and B-ONE PORTABLE viscometers.

















MEASURING SYSTEMS

- 72 MS-DIN
- 74 MS-R
- 75 MS-RV / MS-LV
- 76 MS-BV
- 77 MS-VANES / MS-KREBS
- 78 MS-CHOCOLAT / MS-ULV
- 79 MS-SV
- 80 MS-CP

MS-DIN

These measuring systems are compatible with all instruments in the LAMY RHEOLOGY range except CP 1000/CP 2000 device, GT-300 PLUS and GT-300 PRODIG models.

These measuring systems are compatible with our temperature controls EVA DIN, EVA 100 and RT1 and water jacket CT-DIN and CT-LC.

Name	Reference	
MK - DIN 1	112820	
MK - DIN 2	112821	
MK - DIN 3	112822	
MK - DIN 9	111875	
MB-DIN 1 Tube	112932	
MB-DIN 2 Tube	112937	
MB-DIN 3 Tube	112938	
CAP-DIN 1	112872	
CAP-DIN 2	112877	
CAP-DIN 3	112878	
CAP-DIN 1 Mooney	112874	
ST-R centring tool	114436	
MB-DIN 1 S Tube	112933	
MB-DIN 2 S Tube	112948	
MB-DIN 3 S Tube	112944	

MS-DIN

DIN 11 measuring system
Ref. 112801

DIN 22 measuring system
Ref. 112804

DIN 33 measuring system
Ref. 112805

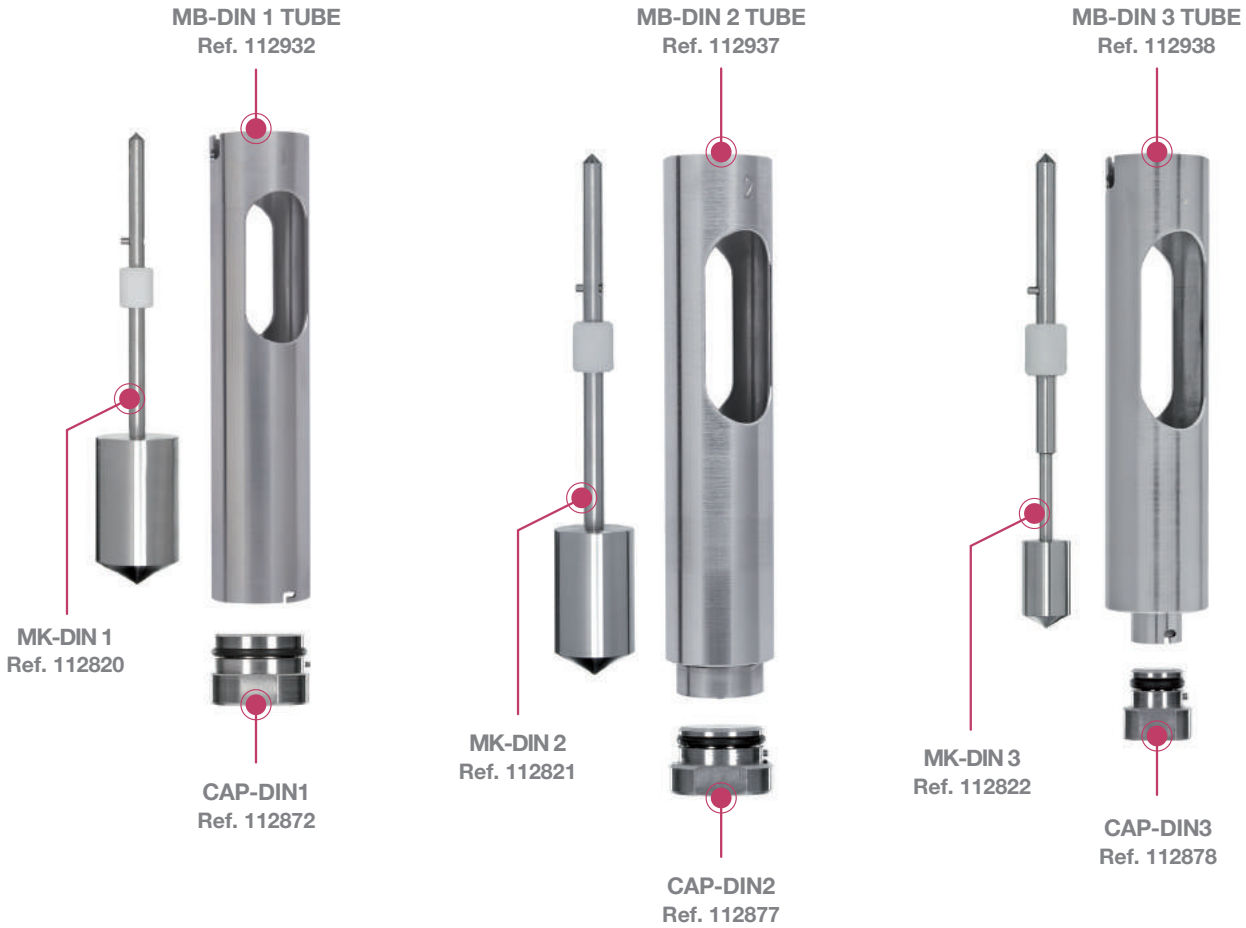

MEASURING SYSTEMS WITH BAYONET COUPLING

Measuring system *		Spindle	Cup	Cap	Volume (ml)	Shear rate (s ⁻¹)**	Viscosity range in mPa.s		
Designation	Reference	Designation	Designation	Designation			Instrument LR**	B-ONE and FIRST**	RM100/200 and DSR500**
MS DIN 11	112801	MK-DIN1	MB-DIN1	CAP-DIN1	27	1,29N	2,5 to 27K	25 to 0.44M	3 to 1M
MS DIN 11S***	112809	MK-DIN1	MB-DIN1S	CAP-DIN1	27	1,29N	2,5 to 27K	25 to 0.44M	3 to 1M
MS DIN 12	112802	MK-DIN2	MB-DIN1	CAP-DIN1	46	0,35N	11 to 145K	110 to 2.3M	18 to 5.5M
MS DIN 13	112803	MK-DIN3	MB-DIN1	CAP-DIN1	61	0,15N	92 to 510K	920 to 8.3M	146 to 19M
MS DIN 13S***	112808	MK-DIN3	MB-DIN1S	CAP-DIN1	22	0,15N	93 to 510K	920 to 8.3M	146 to 19M
MS DIN 19	112806	MK-DIN9	MB-DIN1	CAP-DIN1	25	3,22N	0,8 to 10K	8 to 0.17M	1 to 0.39M
MS DIN 22	112804	MK-DIN2	MB-DIN2	CAP-DIN2	22	1,29N	4 to 53K	40 to 0.86M	7 to 2M
MS DIN 22S***	112815	MK-DIN2	MB-DIN2S	CAP-DIN2	22	1,29N	5 to 53K	40 to 0.86M	7 to 2M
MS DIN 33	112805	MK-DIN3	MB-DIN3	CAP-DIN3	14	1,29N	20 to 265K	200 to 4.3M	34 to 10M
MS DIN 33S***	112814	MK-DIN3	MB-DIN3S	CAP-DIN3	14	1,29N	20 to 265K	200 to 4.3M	34 to 10M
MS DIN 11M	112812	MK-DIN1	MB-DIN1	CAP-MOONEY	23	1,29N	2,5 to 27K	21 to 0.44M	3 to 1M
MS DIN 19M	112811	MK-DIN9	MB-DIN1	CAP-MOONEY	18,5	3,22N	0,8 to 10K	8 to 0.17M	1 to 0.39M
MS DIN 23	112816	MK-DIN3	MB-DIN2	CAP-DIN2	36	0,19N	81 to 1M	810 to 17M	139 to 41M

M for million, K for thousand, N for rotational speed (rpm) / * Complete measuring system with spindle, cup and cap. / ** These values are given when complete system is used. / *** Include centring tool ST-R (Ref. 114436).

MS-R

Anchor-type measuring systems (316L stainless steel).

These systems are ideally suited for measuring viscosity (value or curve) in the control or development of heterogeneous products, or having the appearance of soft solid at rest, present in cosmetics, paint, food or mineral chemistry industries.

Used with their respective buckets, they allow to apply a shear rate.

These systems are compatible with RM 100 PLUS, RM 200 PLUS and DSR 500.

These systems are compatible with our EVA DIN-MS-R PLUS and EVA MS-R PLUS temperature controls.

MS-R 1 measuring system

Ref. 114500

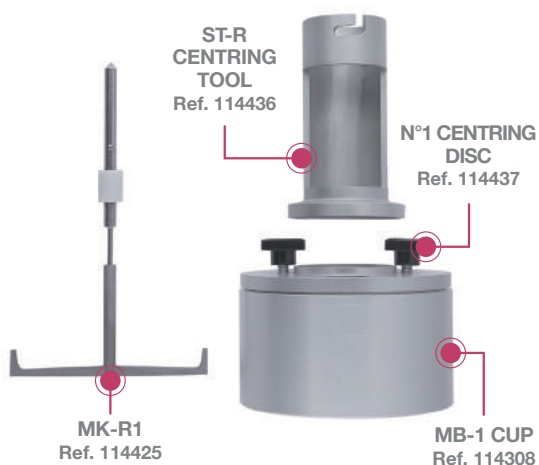

MS-R2 measuring system

Ref. 114501

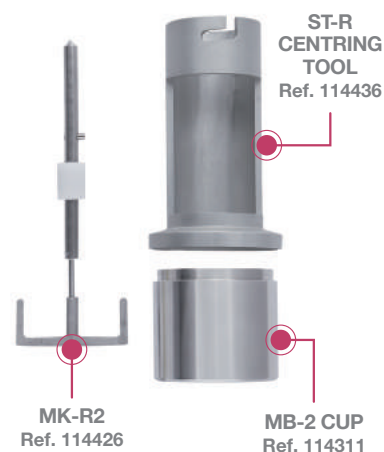

MS-R3 measuring system

Ref. 114502

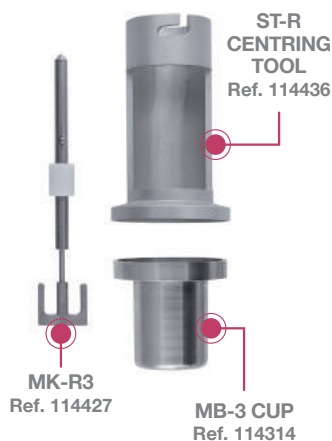

MS-R4 measuring system

Ref. 114503

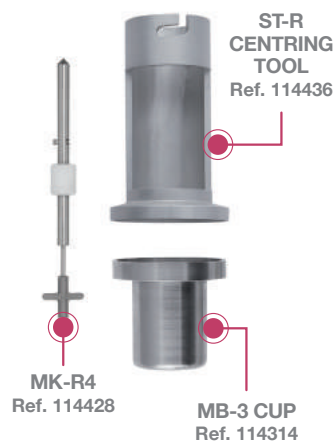













MEASURING SYSTEMS WITH BAYONETTE COUPLING

System Designation	System Reference	Complete set****		Diameter (mm)		Product Volume (ml)	Shear rate range for RM100-200-DSR500 (s ⁻¹)	Viscosity range for RM100-200 (mPa.s)
				inner	outer			
MS-R1***	114500*	111949	111950	93	98	300	200 rpm	1 to 40 UD
MS-R2	114501*			46	54	70	0.105 to 525	12 to 3.6M
MS-R3	114502*			23	36	25	0.09 to 450	72 to 21.6M
MS-R4	114503*			20	36	25	0.075 to 375	400 to 120M
MK-R5	114429**			5			0.03 to 150	1.5K to 475M

M for millions, K for thousand. / * Complete system (bob+cup+centring tool). / ** Only spindle. Can be use with cup MB2 (Ref. 114311) and MB3 (Ref. 114314). / *** Can be used only at 200 rpm and UD result. / **** Complete set in case with cup and centring tool. / All data given in this table are given for information and can be changed according container used for measurement.

MS-RV / MS-LV

Measuring spindles according to ASTM / ISO 2555 (316L stainless steel). These systems are ideally suited for simple viscosity measurement at controlled rotational speed in all areas of activity. The standard recommends use of 600ml beaker for measurement.

Name	Reference	Dimensions (mm)	
LV-1 spindle	111010	Ø 18,80 - L 65,1	
LV-2 spindle	111011	Ø 18,72 - L 6,86	
LV-3 spindle	111012	Ø 12,60 - L 1,78	
LV-4 spindle	111013	Ø 3,20 - L 31	
Axis R 1-6 without disc	111000	Threaded axis	
RV-1 Disc	111001	Ø 56,26	     
RV-2 Disc	111002	Ø 46,93	
RV-3 Disc	111003	Ø 34,69	
RV-4 Disc	111004	Ø 27,30	
RV-5 Disc	111005	Ø 21,14	
RV-6 Disc	111006	Ø 14,62	
RV-7 Spindle	111007	Ø 3,20	
Axis L-R	111008	Adaptation axis	

SPINDLES WITH BAYONETTE COUPLING

Spindle Designation	Spindle Reference	Complete set** Reference	Instrument LR	Viscosity range in mPa.s	
				FIRST/B-ONE	RM100-200 and DSR500
RV1	111001*	111947 / 111948	Not Usable	100 to 0.6M	50 to 1.4M
RV2	111002*		200 to 0.14M	200 to 2.4M	100 to 5.5M
RV3	111003*		300 to 0.37M	300 to 6M	150 to 14M
RV4	111004*		400 to 0.74M	600 to 12M	200 to 28M
RV5	111005*		500 to 1.4M	1.2K to 24M	300 to 55M
RV6	111006*		1200 to 3.7M	2.8K to 60M	500 to 130M
RV7	111007		4500 to 15M	12K to 240M	2K to 550M
LV1	111010	111014	15 to 0.25M	200 to 4.3M	35 to 10M
LV2	111011		50 to 1.3M	1K to 20M	170 to 50M
LV3	111012		200 to 5M	4k to 82M	650 to 190M
LV4	111013		1000 to 22M	17K to 370M	3K to 860M

M for millions, K for thousand / * Need additional axis (Ref. 111000). / ** Complete set (delivered with axis Ref. 111000 only for RV spindles).









MS-BV

Measuring spindle for 150ml beaker (316L stainless steel).

These spindles are ideally suited for simple viscosity measurement at a rotating speed in control in all areas of activity. They are appreciated for their ease of use and the low volume of product needed compared to the MS RV/LV spindle.

These measuring spindles are compatible with instruments in LR version.

Compatible with EVA BV temperature control (price and item on demand).

	Name	Reference	Dimension (mm)
	BV 1-100 Axis	117102	-
	BV centring device	117202	-
	BV Disc n°1	117001	Ø 45
	BV Disc n°10	117010	Ø 40
	BV Disc n°100	117100	Ø 20
	BV 1000 Axis	117101	Ø 4
	150-ml glass beaker	117150	Ø 50-52
	MS TI Tube	118001	Ø 50

MEASURING SPINDLES WITH BAYONET COUPLING

Designation	Reference**	Complete Set*** reference	Viscosity range FIRST/B-ONE (mPa.s)	Viscosity range RM100/200/DSR 500 (mPa.s)
BV1	117001*	117000	15 to 0.25M	2 to 0.6M
BV10	117010*		100 to 2M	17 to 5.1M
BV100	117100*		1K to 22M	170 to 51M
BV1000	117101		10K to 220M	1.7K to 510M

*M for million, K for thousand / Use with glass beaker (Ref. 117150 for 10pcs) or plastic beaker (Ref. 117155 for 10 pcs). / * Require additional axis (Ref. 117102). / ** Require centring tool (Ref. 117202). / *** Compleat Set in case with additional axis (Ref. 117102) and centring tool (Ref. 117202).*

MS-VANES

These systems are ideal for viscosity measurement (value or curve) in control or development of all types of products even very high viscosity with or without particles (size <5mm). They can be used for direct measurement in user's containers or in tubes of MS-DIN systems.



4 blades VANES



6 Blades VANE



MEASURING SYSTEMS WITH BAYONET COUPLING

Designation	Reference	Diameter (mm)	Length (mm)	Viscosity range in mPa.s		
				LR Device	B-ONE/FIRST	RM100/200 DSR500
MK-V71	111114	34,39	68,78	1,4 to 18K	14 to 300K	2,4 to 700K
MK-V72**	120017	21,67	43,38	5,6 to 74K	56 to 1,2M	9,4 to 2,8M
MK-V73**	111108	12,67	25,35	28 to 370K	280 to 6M	46 to 13M
MK-V74**	111115	5,89	11,76	280 to 3,7M	2,8K to 60M	463 to 139M
MK-V75**	111111	8,026	16,05	111 to 1,4M	1,1K to 24M	185 to 55M
MK-V72/2**	111112	21,67	20	54 to 720K	540 to 11M	90 to 27M
MK-V72/4**	111113	21,67	10	80 to 1M	800 to 17M	133 to 40M
MK-V72-6P*	111121	21,67	43	30 to 400K	300 to 6,5M	50 to 15M
MK-VT105**	440105	5	10	430 to 5,8M	4,4K to 94M	726 to 218M
MK-VT2010**	442010	10	20	82 to 1M	820 to 17M	137 to 41M
MK-VT2020**	442020	20	20	12 to 150K	118 to 2,5M	20 to 5,9M
MK-VT3015**	443015	15	30	16 to 210K	160 to 3,4M	27 to 8M
MK-VT4020**	444020	20	40	7 to 90K	68 to 1,4M	11 to 3,4M
MK-VT4040	444040	40	40	1,5 to 19K	15 to 320K	2,5 to 740K
MK-VT5025**	445025	25	50	4 to 45K	34 to 730K	6 to 1,7M
MK-VT6015	446015	15	60	9 to 114K	86 to 1,8M	15 to 4,3M
MK-VT6030	446030	30	60	2 to 26K	20 to 433K	3,5 to 1M
MK-VT608	446008	8	60	30 to 400K	300 to 6,5M	50 to 15M
MK-VT8040	448040	40	80	1 to 11K	9 to 182K	2 to 420K
MK-VT8070	448070	70	80	0,5 to 3,2K	3 to 52K	1 to 120K

M for million, K for thousand / * VANE 6 BLADES. / ** These items can be used with tube MB-DIN1 (Ref.112932).

MS-KREBS

Krebs type measuring spindles compatible with ASTM D562 standard (316L stainless steel). These systems are ideal for viscosity measurement in Krebs units in control of all types of products. They can be used for direct measurement in user containers or in 600 or 150ml beakers.





Name	Reference	Dimension (mm)	
MK-KU 1-10	111100	L. 54,11	
MK-75Y	111103	L. 34,58	

MS-CHOCOLAT

Coaxial cylinder measuring system compatible with OICCC standard (316L stainless steel).

These measuring spindle measure viscosity and flow limit of chocolates according to Casson regressions models as recommended in OICCC standards.

These measuring systems are compatible with our EVA DIN, EVA 100 temperature controls and our water jacket CT-DIN and CT-LC.







	Name	Reference	Dimension (mm)
	MK-C	116002	Ø 13,60
	C Tube with insert	116001	Ø 20
	DIN 1 Tube	112932	Ø 32,50
	C Insert	116004	Ø 20
	Delrin cap	116005	-

MS-ULV

Measuring system for low viscosities usable with instruments LR version (Stainless steel 316L and Aluminium).

This system, unlike the MS-RV/LV or MS-DIN systems, makes it possible to measure low viscosity products in control by applying a shear rate. Its advantage is to be compatible with LR instruments.

This measuring system can be used with our temperature controls EVA DIN and RT1 and our water jackets CT-DIN and CT-LC (according to models, see table).

Name	Reference	Dimension (mm)	
MK-C19	116015P	Ø 19	
C Tube with insert	116001	Ø 20	
Delrin cap	116005	-	
C Insert	111934	-	
ST-R centring tool	114436	-	
MB-C Alu Cup	114306	Ø 20	

MEASURING SYSTEMS WITH BAYONET COUPLING FOR LR DEVICE

Designation	Reference	Included					Volume (ml)	Shear rate range (s ⁻¹)	Viscosity range (mPa.s)
		Spindle	Cup	Holder	Cap	Tool			
MS-ULV*	116030	116015P	116001		116005		11	1 to 510 33 to 750K(HR)	
MS-ULV/D**	116031	116015P	114306	111394		114436	11		

*K for thousand / * Not compatible with oven RT1. Can be used without temperature unit. / ** Include 100 disposable cup (Ref. 114306). Must be used with temperature unit or water jacket.*

MS-SV

Measuring systems for low volumes (316L stainless steel or aluminium).
 These systems make it possible to measure products in small quantities by applying a shear rate at temperature up to +300°C (according to items, see table).
 With RT1 and THERMOCELL package, these systems are compatible with ASTM D3236.
 These measuring systems are compatibles with small volume package SVP65/180, water jacket CT-DIN/CT-LC, THERMOCELL package and our temperature controls EVA DIN and RT1.

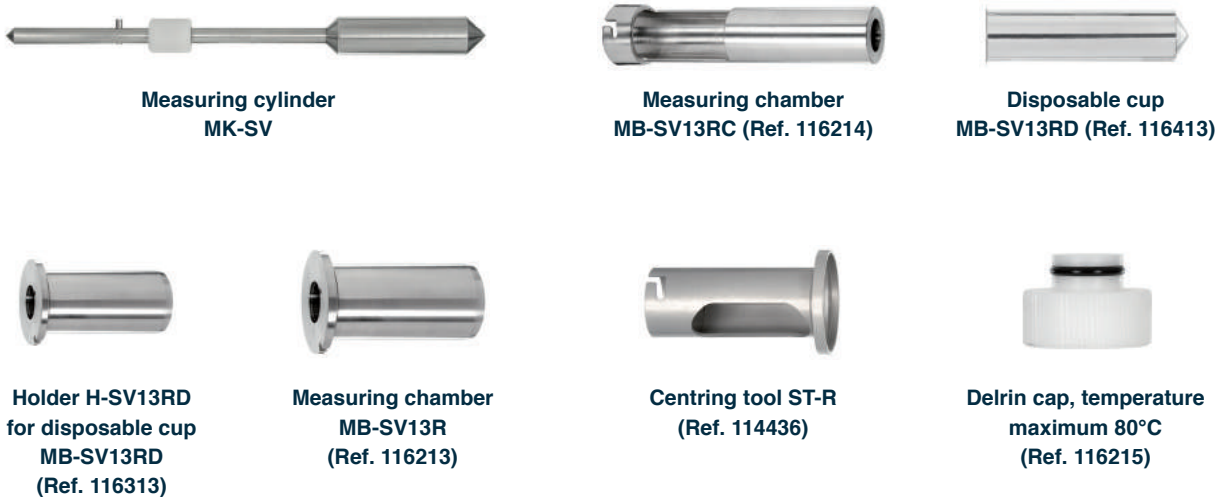

MEASURING SYSTEMS WITH BAYONET COUPLING

Measuring Cylinder		Compatible chamber****		Volume (ml)	Shear rate (s-1)	Viscosity range in mPa.s		
Designation	Reference	Designation	Reference			LR device	B-ONE/FIRST	RM100/RM200/DSR500
MK-SV414*	116114	MB-SV6R*	116206	3	0,4N	44 to 5,8M	440 to 95M	73 to 219M
MK-SV415*	116115	MB-SV7R*	116207	4,4	0,48N	15 to 2M	155 to 33M	26 to 77M
MK-SV416*	116116	MB-SV8R*	116208	4,6	0,29N	39 to 5,2M	394 to 85M	66 to 197M
MK-SV418	116118	MB-SV13R MB-SV13RC** MB-SVD***	116213 116214 116513	7,5	1,32N	1 to 120K	9 to 1,9M	2 to 4,5M
MK-SV421	116121			8	0,93N	1 to 188K	14 to 3M	2 to 7M
MK-SV425	116125			10	0,22N	174 to 23M	1,7K to 377M	291 to 870M
MK-SV427	116127			12	0,34N	7 to 0,99M	75 to 16M	12 to 37M
MK-SV428	116128			13	0,28N	15 to 1,9M	147 to 31M	24 to 73M
MK-SV429	116129			13	0,25N	29 to 3,9M	294 to 63M	49 to 146M
MK-SV431	116131			11	0,34N	10 to 1,3M	100 to 21M	16 to 49M
MK-SV434	116134			11	0,28N	19 to 2,5M	194 to 41M	32 to 96M
MK-SVC	116002			13	0,43N	3 to 420K	32 to 6,8M	5 to 15M
MK-SVTR8	140008			8	0,92N	1 to 190K	14 to 3M	2 to 7M
MK-SVTR9	140009			12	0,34N	7 to 0,99M	75 to 16M	12 to 37M
MK-SVTR10	140010			13	0,28N	15 to 1,9M	146 to 31M	24 to 72M
MK-SVTR11	140011			13	0,25N	30 to 3,9M	300 to 64M	50 to 149M

M for million, K for thousand, N for rotational speed (rpm). / * Not compatible with RT-1PLUS and THERMOCELL PACKAGE. / ** This cup can be used without centring tool ST-R. Need CAP (Ref. 116215). Temperature max 80°C. / *** This item include 100 disposable cup MB-SV13RD (Ref. 116413) and holder H-SVRD (Ref. 116313). / **** These items need centring tool ST-R (Ref. 114436 include with THERMOCELL and SVP65/180).

MS-CP

Measuring systems compatible with DIN 53019 / ISO 3219 / ASTM D4278-D7395 (316L Stainless Steel). These systems make it possible to set the shear rate in order to carry out viscosity measurements or to obtain curves to study flow behaviour, yield stress or thixotropy.

They are particularly suitable for measurements on very small quantities for control or development of homogeneous products with or without particles (size <100µm), guaranteeing easy cleaning.

AC 265 coupling guarantees rapid set-up of the measuring system, better maintenance and increased repeatability.

These measuring systems are compatible with FIRST PRODIG CP1000, RM100 CP10000 and RM100 CP2000.



MEASURING SYSTEMS FOR CP1000 AND CP2000 INSTRUMENTS

Designation	Reference	Diameter (mm)	Angle (°)	Volume (ml)	Shear rate (s ⁻¹)	Viscosity range in mPa.s	
						FIRST PRODIG CP1000	RM100 CP1000 / CP2000
MK-CP1005	265115	10	0,5	0,002	12N	640 to 130M	106 to 318M
MK-CP1020	265120	10	2	0,01	3N	2,5K to 550M	424 to 1270M
MK-CP1030	265130	10	3	0,01	2N	3,8K to 800M	637 to 1910M
MK-CP06	2651418	14,04	1,8	0,02	3,3N	840 to 180M	139 to 418M
MK-CP03	2651945	19,06	0,45	0,015	13,3N	85 to 18M	14 to 41M
MK-CP05	2651918	19,06	1,8	0,05	3,3N	335 to 72M	56 to 167M
MK-CP09	2651930	19,06	3	0,1	2N	550 to 119M	92 to 273M
MK-CP2005	265205	20	0,5	0,018	12N	80 to 17M	13 to 39M
MK-CP2015	265215	20	1,59	0,058	3,8N	250 to 54M	42 to 125M
MK-CP2020	265202	20	2	0,073	3N	320 to 68M	53 to 159M
MK-CP02	2652445	24	0,45	0,03	13,3N	42 to 9M	7 to 20M
MK-CP2405	265245	24	0,5	0,031	12N	46 to 10M	8 to 23M
MK-CP51Z	2652415	24	1,5	0,1	4N	140 to 29M	23 to 69M
MK-CP04	2652418	24	1,8	0,12	3,3N	170 to 36M	28 to 83M
MK-CP2420	265242	24	2	0,126	3N	190 to 39M	31 to 92M
MK-CP52Z	265243	24	3	0,2	2N	280 to 59M	46 to 138M
MK-CP01	265345	30,2	0,45	0,06	13,3N	20 to 4M	3 to 10M
MK-CP10	2653012	30,2	1,2	0,15	5N	60 to 12M	9 to 27M
MK-CP08	2653030	30,2	3	0,38	2N	140 to 30M	23 to 69M
MK-CP4005	265405	40	0,5	0,146	12N	10 to 2M	2 to 5M
MK-CP4010	265401	40	1	0,29	6N	20 to 4M	3 to 10M
MK-CP4015	265515	40	1,59	0,465	3,8N	32 to 7M	5 to 15M
MK-CP4020	265402	40	2	0,585	3N	40 to 8M	7 to 20M
MK-CP4040	265404	40	4	1,17	1,5N	80 to 17M	13 to 40M
MK-CP07	2654830	48	3	1,5	2N	35 to 7M	6 to 17M
MK-CP40Z	265488	48	0,8	0,4	7,5N	9 to 2M	2 to 4M
MK-CP42Z	2654815	48	1,5	0,76	4N	18 to 3M	3 to 8M
MK-CP41Z	265483	48	3	1,5	2N	35 to 7M	6 to 17M
MK-CP5005	265505	50	0,5	0,285	12N	5 to 1M	1 to 2M
MK-CP5020	265502	50	2	1,142	3N	21 to 4M	3 to 10M
MK-CP6005	265622	60	0,5	0,5	12N	3 to 0,6M	1 to 1M
MK-CP6010	265610	60	1	1	6N	6 to 1M	1 to 3M
MK-CP6020	265602	60	2	2	3N	12 to 2,5M	2 to 6M
MK-CP6030	265603	60	3	3	2N	18 to 3M	3 to 9M

M for million, K for thousand, N for rotational speed (rpm)

MS-CP

Measuring systems compatible with DIN 53019 / ISO 3219 / ASTM D4278-D7395 (316L Stainless Steel).
 All cones-plate presented on this page present a truncation (50µm) compatible with our instruments with automatic lift.
 They are particularly suitable for measurements on very small quantities for control or development of homogeneous products with or without particles (size <5µm for cone-plate), guaranteeing easy cleaning.
 AC 265 coupling guarantees rapid set-up of the measuring system, better maintenance and increased repeatability.
 These measuring systems are compatible with RM200 CP4000 and DSR500 CP4000.



MK-CP 20 mm AC 265



MK-CP 50 mm AC 265

MEASURING SYSTEMS FOR RM200/DSR500 CP4000 PLUS

Designation	Reference	Diameter (mm)	Angle (°)	Volume (ml)	Shear rate (s-1)	Viscosity range (mPa.s)
MK-CP1010	365101	10	1	0,005	6N	212 to 636M
MK-CP2005	365205	20	0,5	0,018	12N	13 to 39M
MK-CP2010	365210	20	1	0,04	6N	26 to 79M
MK-CP2020	365202	20	2	0,073	3N	53 to 159M
MK-CP2404	365244	24	0,45	0,03	13,3N	7 to 20M
MK-CP2405	365245	24	0,5	0,031	12N	8 to 23M
MK-CP3510	365351	35	1	0,2	6N	5 to 14M
MK-CP4005	365405	40	0,5	0,146	12N	2 to 5M
MK-CP4010	365401	40	1	0,29	6N	3 to 10M
MK-CP4020	365402	40	2	0,585	3N	7 to 20M
MK-CP4040	365404	40	4	1,17	1,5N	13 to 40M
MK-CP5005	365505	50	0,5	0,285	12N	1 to 2,4M
MK-CP5020	365502	50	2	1,142	3N	3 to 10M
MK-CP6010	365601	60	1	1	6N	1 to 3M
MK-CP6020	365602	60	2	2	3N	2 to 6M
MK-CP6050	365605	60	5	5	1,2N	5 to 15M
MK-PP20*	265020	20		0,314	1N	200 to 611M
MK-PP25*	265025	25		0,491	1,3N	83 to 248M
MK-PP28*	265028	28		0,616	1,5N	52 to 157M
MK-PP35*	265035	35		0,962	1,8N	22 to 65M
MK-PP40*	265040	40		0,63	4,2N	6 to 19M
MK-PP50*	265005	50		1	5,2N	3 to 7,8M

M for million, K for thousand, N for rotational speed (rpm) / * Given values for gap 1mm

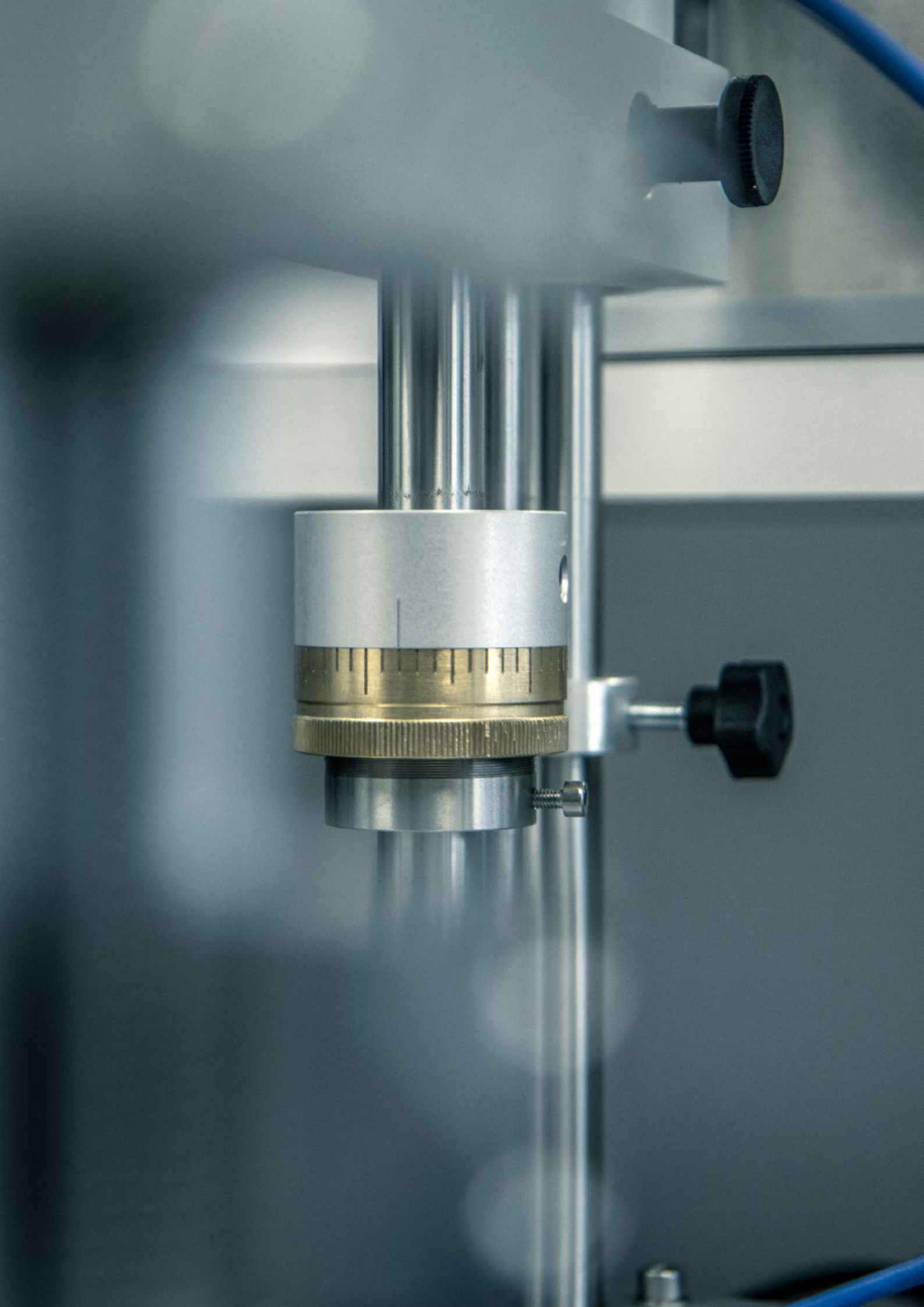

SERVICES & SUPPORT

- 84 APPLICATIONS
- 85 TRAINING
- 86 CHECKING, CALIBRATION
AND SERVICE
- 87 DISTRIBUTORS

APPLICATIONS

FIND ALL OUR APPLICATIONS NOTES ON OUR WEB SITE

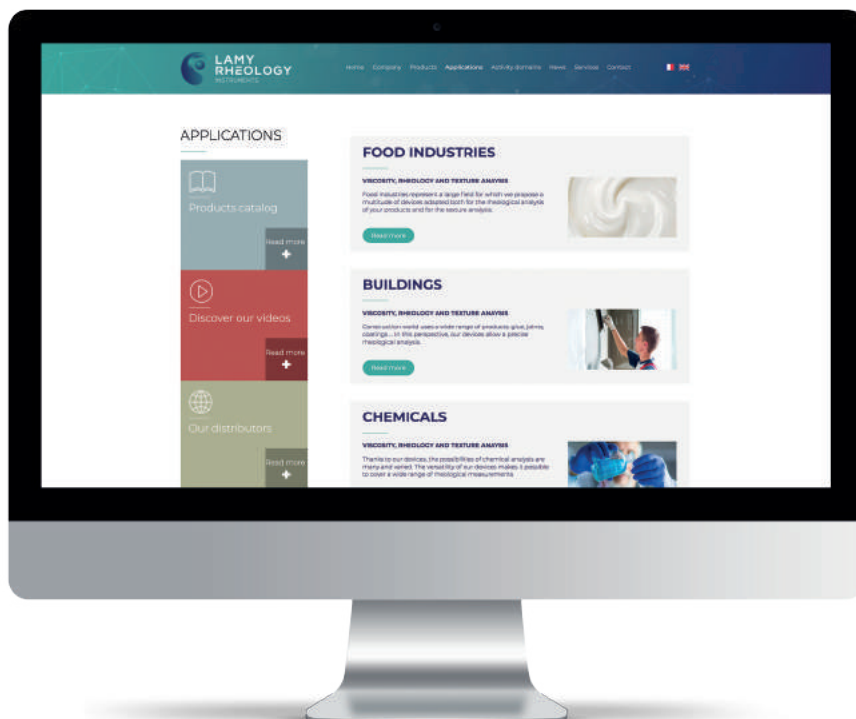

TRAINING

Four values to meet your training needs

Availability:

Our partners will propose regular visits so you can optimise your products and they will help you set the perfect measurement conditions.

Performance:

Our instruments are demonstrated using your samples to help you choose the right equipment for your needs.

Compliance:

IQ procedures: a technician will take charge of documenting the installation so that you can start using your equipment immediately.
OQ Procedures: verification that results are obtained from the first measurement by ensuring that the equipment meets specifications in the given environment.

Expertise:

Rheology training sessions applied in the business: understand and explain physical phenomenon revealed by the rheological behavior and texture analyses of your formulations.

“ “ Because understanding each and every one of our customers means we can meet everyone's expectations! ” ”

CHECKING, CALIBRATIONS AND MAINTENANCE

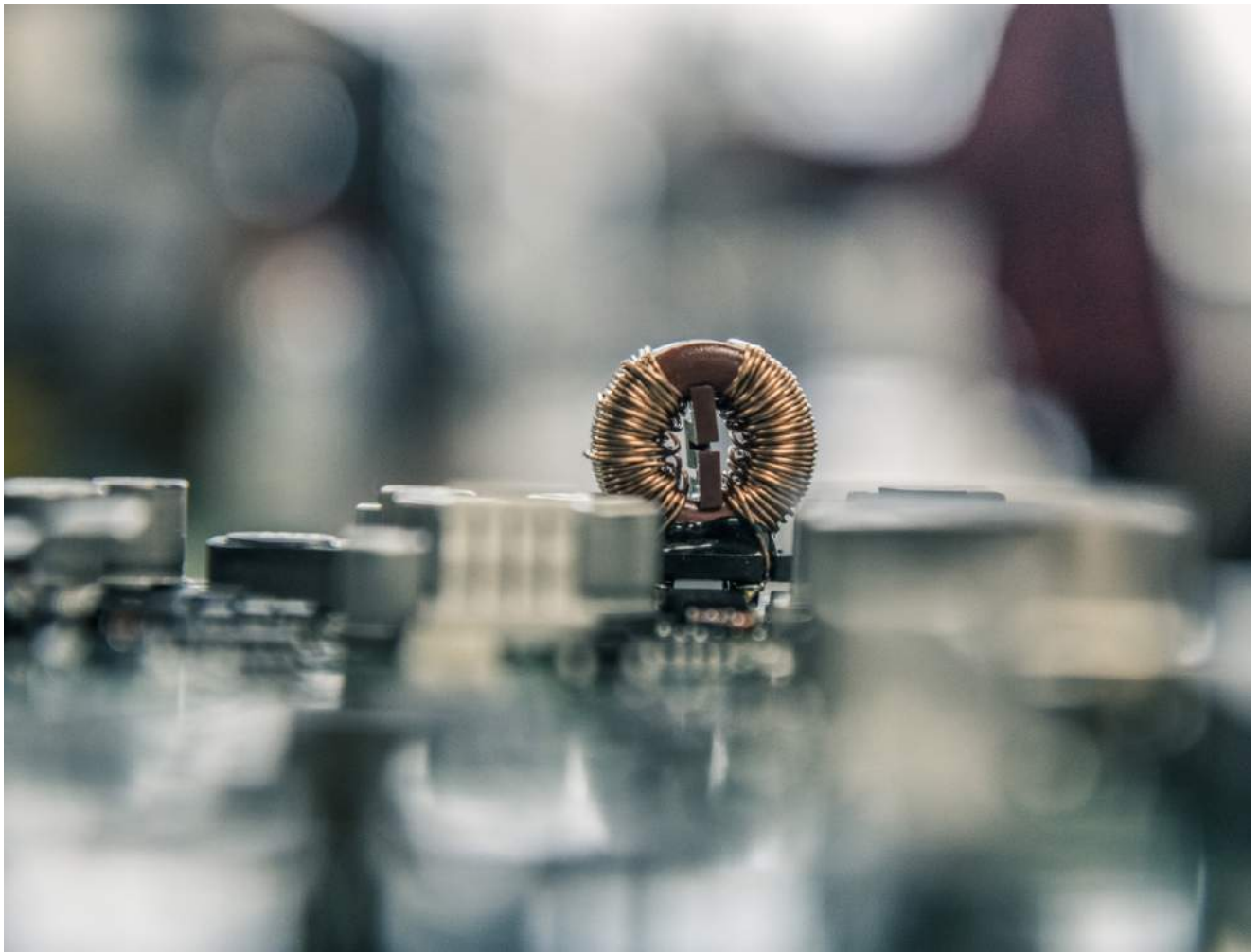

Guaranteed smooth running of your instruments.

Planned calibration and preventive maintenance, carried out by our trained and certified technicians, are essential to guarantee your instruments run smoothly so that productivity is increased and reliable, accurate measurements are obtained.

So you can benefit from our technicians' experience, we offer:

- Calibration with validation certificates (assessment of your device and free quote).
- Provision of verification oils.
- Tests according to your conditions of use.



BIOTECH



PHARMA



F&B



COSMETICS



FMCG



PAINTS



CHEMICALS



AUTOMOBILE



ELECTRONICS



AGRICULTURE

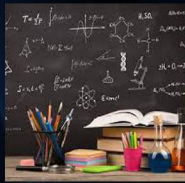

EDUCATION



INFRASTRUCTURE



OIL & GAS



DEFENCE



LAMY RHEOLOGY

Алматы (727)345-47-04
 Ангарск (3955)60-70-56
 Архангельск (8182)63-90-72
 Астрахань (8512)99-46-04
 Барнаул (3852)73-04-60
 Белгород (4722)40-23-64
 Благоевщенск (4162)22-76-07
 Брянск (4832)59-03-52
 Владивосток (423)249-28-31
 Владикавказ (8672)28-90-48
 Владимир (4922)49-43-18
 Волгоград (844)278-03-48
 Вологда (8172)26-41-59
 Воронеж (473)204-51-73
 Екатеринбург (343)384-55-89

Россия +7(495)268-04-70

Иваново (4932)77-34-06
 Ижевск (3412)26-03-58
 Иркутск (395)279-98-46
 Казань (843)206-01-48
 Калининград (4012)72-03-81
 Калуга (4842)92-23-67
 Кемерово (3842)65-04-62
 Киров (8332)68-02-04
 Коломна (4966)23-41-49
 Кострома (4942)77-07-48
 Краснодар (861)203-40-90
 Красноярск (391)204-63-61
 Курск (4712)77-13-04
 Курган (3522)50-90-47
 Липецк (4742)52-20-81

Казахстан +7(727)345-47-04

Магнитогорск (3519)55-03-13
 Москва (495)268-04-70
 Мурманск (8152)59-64-93
 Набережные Челны (8552)20-53-41
 Нижний Новгород (831)429-08-12
 Новокузнецк (3843)20-46-81
 Ноябрьск (3496)41-32-12
 Новосибирск (383)227-86-73
 Омск (3812)21-46-40
 Орел (4862)44-53-42
 Оренбург (3532)37-68-04
 Пенза (8412)22-31-16
 Петрозаводск (8142)55-98-37
 Псков (8112)59-10-37
 Пермь (342)205-81-47

Беларусь +3(75)257-127-884

Ростов-на-Дону (863)308-18-15
 Рязань (4912)46-61-64
 Самара (846)206-03-16
 Санкт-Петербург (812)309-46-40
 Саранск (8342)22-96-24
 Саратов (845)249-38-78
 Севастополь (8692)22-31-93
 Симферополь (3652)67-13-56
 Смоленск (4812)29-41-54
 Сочи (862)225-72-31
 Ставрополь (8652)20-65-13
 Сургут (3462)77-98-35
 Сыктывкар (8212)25-95-17
 Тамбов (4752)50-40-97
 Тверь (4822)63-31-35

Узбекистан +998(71)205-18-59

Тольятти (8482)63-91-07
 Томск (3822)98-41-53
 Тула (4872)33-79-87
 Тюмень (3452)66-21-18
 Улан-Удэ (3012)59-97-51
 Ульяновск (8422)24-23-59
 Уфа (347)229-48-12
 Хабаровск (4212)92-98-04
 Чебоксары (8352)28-53-07
 Челябинск (351)202-03-61
 Череповец (8202)49-02-64
 Чита (3022)38-34-83
 Якутск (4112)23-90-97
 Ярославль (4852)69-52-93

Киргизия +996(312)96-26-47

<https://lamy.nt-rt.ru> || aym@nt-rt.ru